



POWER, PRECISION, PRICE...



INTRODUCING THE THARO H-400 Series and H-600 Series PRINTERS.

NO OTHER PRINTERS WILL BE ABLE TO COMPARE TO THE NEW THARO LINE - THEY ARE SIMPLY THE BEST PRICE VERSUS PERFORMANCE PRINTERS AVAILABLE!



H-400

H-600

The THARO H-400/H-600 Series are high quality, easy-to-use, reliable, and durable printers that are perfect for ALL types of industries and applications.

The THARO H-400/H-600 Series printers have been designed for low maintenance and ease of operation, plus the options and accessories are available at very affordable prices, so the overall cost of ownership is kept to a minimum.

Many features that are optional with other printers are standard on the H-400/H-600 Series such as: Flash Memory to store files, the Real-Time Clock, the Stripper Sensor (H-400 Series only) and the FREE EASYLABEL Start labeling software.

Look at the features and we are sure you will agree that the H-400/H-600 truly are the best performing, most precise printers available at a very attractive price.

Printer Basics

A list of standard features that on other printers looks like a list of options

- ◆ The new THARO H-400/H-600 Series printers have an elegant design, are extremely compact and are robust enough for commercial use.
- ◆ The H-400/H-600 Series printers feature durable, all metal construction with a cast Aluminum center wall and a large media window for easy viewing and monitoring of supplies.
- ◆ The standard Stripper Sensor on the H-400 Series senses printed labels in either peel and present or tear-off applications.
- ◆ Thin film Printheads used in the H-400/H-600 Series printers provide high quality output, even with stepladder bar codes, in either 203 (H-427/H-626) or 300 (H-436/H-634) dpi.
- ◆ The H-400/H-600 Series printers are extremely versatile. No PC is necessary. Download your label formats to the Printer's Flash Memory (or a CompactFlash Card), unplug the printer from the PC, plug in a standard PC keyboard, and take it to another location.
- ◆ The H-400/H-600 Series printers are extremely easy to install options, accessories and to service.
- ◆ Print in 203 or 300 dpi resolution with the same H-400/H-600 printer. Simply exchange a 203 dpi Printhead for a 300 dpi Printhead without using tools or making configuration changes.
- ◆ The H-400/H-600 Series printers feature a 450m (1476') ribbon capacity and a full 203mm (8") O.D. label roll capacity making them suitable for large volume printing requirements.
- ◆ The H-400/H-600 Series printers are designed to accept ribbon types of both ink inside and ink outside, providing more flexibility in ribbon selection.
- ◆ USB 2.0 is standard on the H-400/H-600 Series printers for high-speed data transfer from your PC.
- ◆ The H-400/H-600 Series printers feature a Standard Real-Time Clock for time and date stamping of labels.

Simple Operation

- ◆ The H-400/H-600 Series printers feature a large, easy-to-read backlit LCD graphic display for set-up, operator prompting and messages.
- ◆ Prompts and messages are available in several languages, which makes the Printers ideal for multi-national companies. Languages include: English, Chinese (Simplified and Traditional), Dutch, French, German, Italian, Spanish and Turkish.
- ◆ Open media path provides easy access to ribbon and label stock, and makes loading the printer with consumables a simple operation.
- ◆ The Label Edge Sensor is EASY to adjust on the H-400/H-600 Series printers.
- ◆ The Drive Roller in the H-400/H-600 Series printers is EASY to replace.



Software

Each H-400/H-600 Series printer comes with a FREE Accessory CD that contains documentation and all the software required to start printing labels with the THARO H-400/H-600 printers.

What is included on the Accessory CD:

- ◆ A FREE labeling package called EASYLABEL[®] Start.
- ◆ A Demo of the Platinum version EASYLABEL.
- ◆ EasyTutor: The multimedia training companion to EASYLABEL.
- ◆ Drivers for Microsoft Windows.
- ◆ CUPS (Common UNIX Printing System) Driver for UNIX, Linux and Mac.
- ◆ The H-400/H-600 Series Quick Start Guide.
- ◆ The H-400/H-600 Series Users Manual.
- ◆ The THARO Programming Language Manual with examples.



Powerful Electronics

- ◆ The H-400/H-600 Series printers have 16MB SDRAM and 4MB Flash Memory for fast printing and file storage.
- ◆ A CompactFlash Card inserted into the CompactFlash socket can be used for additional file storage.
- ◆ The Printhead on the H-400/H-600 Series printers can be replaced or exchanged without using tools.
- ◆ The power supply is equipped with auto-voltage detection. Just plug it in and go.
- ◆ The H-400/H-600 Series printers automatically sense where the data is coming from, which means that it is no longer necessary to select an interface from the front panel. This makes setting up the printer even easier.
- ◆ A Stripper Sensor to sense printed labels in either peel-and-present or tear-off applications is standard on the H-400 Series.
- ◆ A Real-Time Clock for time and date stamping of labels is standard on H-400/H-600 Series printers.
- ◆ The H-400/H-600 Series feature easy to upgrade firmware.
- ◆ The H-400/H-600 Series printers use the Easy-to-learn THARO Programming Language (TPL) if you need to do any direct programming.



Tharo H-436 used with the PA1200cw Corner-Wrap to apply labels around the corner of a product.



Tharo H-436 used with the PA1200dt Dual Tamp to apply labels to both the front and top of a product.

Modes

Some optional accessories REQUIRED

BASIC Printer

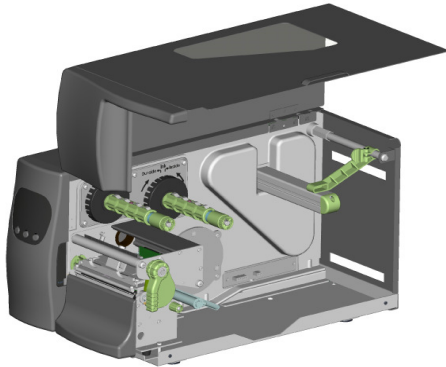

Use the standard printer as delivered to print batches of labels or use with the standard Stripper Sensor (H-400 Series) in Tear-off mode.

Cutter

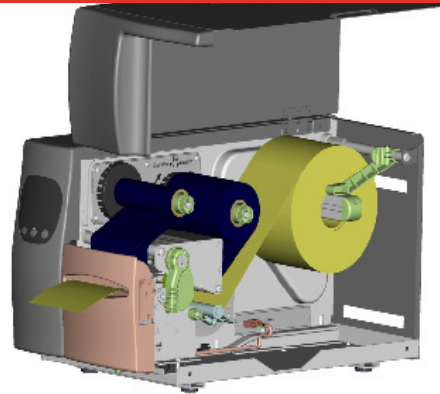

Use the optional Cutter to cut labels or tag stock between labels, after batches of labels, or at the end of a job.

Label Rewind

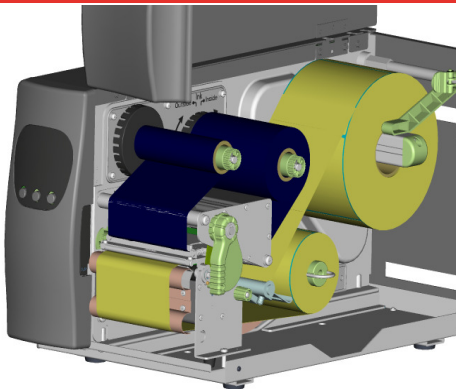

Use the optional Internal Rewind and Rewind Bracket to wind labels after printing.

Peel-and-present

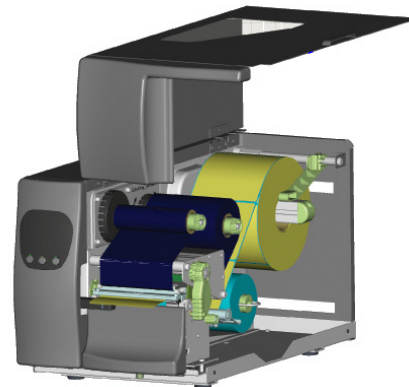

Use the optional internal rewind with the stripper sensor (standard on H-400 series, optional on H-600 series) to rewind the label liner after printing labels in peel-and-present mode.

Interfaces

VERSATILITY? ABSOLUTELY!

Multiple Interfaces for Every Application

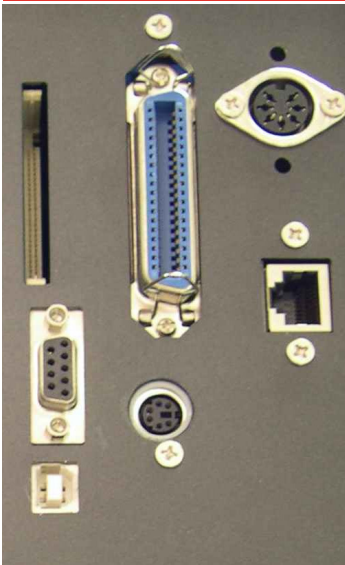

1. **Parallel**
2. **Serial RS 232C** up to 115,200 Baud
3. **USB 2.0** for high-speed data transfer from your PC
4. **PS/2** Keyboard port
5. An optional **Applicator Interface** provides a means of communications between an applicator and the H-400/H-600 Series printers
6. An optional internal **Ethernet Interface Card** provides networking capability giving you the ability to print labels on a printer located anywhere in the world!
7. An optional **Wireless Ethernet Interface Card** allows you to connect to your WLAN and print wirelessly.

OR...

CUT THE CORD! Print WITH NO PC ATTACHED!

PS/2 Port Provides Versatile Stand-alone Capabilities

- ◆ The THARO H-400/H-600 Series printers are extremely versatile. No PC is necessary. Download your label formats to the printer's Flash Memory (or a CompactFlash Card), unplug the Printer from the PC and take it to another location.
- ◆ If you're concerned about the additional cost of a computer, saving work space, harsh environments for computers and training "computer" operators, then "cut the cord" from your computer with the THARO H-400/H-600 Series printers.
- ◆ Variable data can be input directly via any standard PS/2 keyboard.
- ◆ Files such as label formats, fonts, databases, and graphics can be stored in the printer's on-board Flash Memory or a CompactFlash Card.
- ◆ Easily Expand the amount of Flash storage by inserting any inexpensive and easy-to-find CompactFlash Card. The printer will automatically format the card for use the next time the printer is turned on.

HIGH PERFORMANCE

**Real-Time
Clock is
STANDARD.**

**Uses either
coated side in or
coated side out
ribbon, up to 450
meters long.**

**LCD Graphic Display
with prompts and
messages in several
languages.**

**3 button
Keypad for
EASY operation.**

**Built in Stripper Sensor
for strip-and-peel
applications (H-400
Series).**

**A peripheral connection for
a Cutter or Internal
Rewind.**

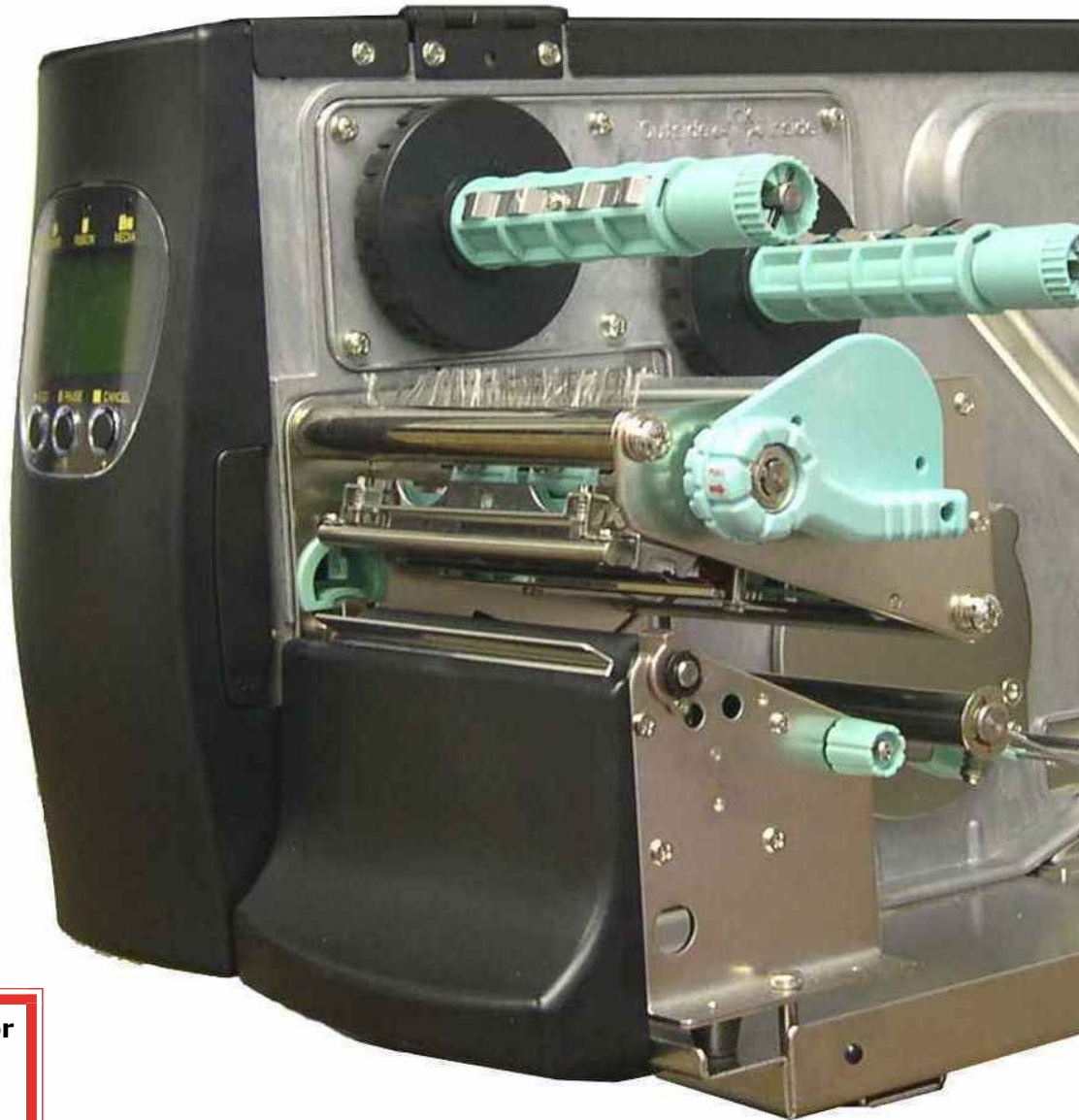

HEAVY DUTY

Open media path allows EASY loading of label stock and ribbon.

**Use without a computer!
Attach a PS/2 keyboard to print labels stored in Flash without a computer!**

Connect with Serial, Parallel, USB, Ethernet (optional), or Wireless Ethernet (optional).

Exchange Printheads to print in 203 or 300 dpi without using tools or making configuration changes.

Heavy-Duty all metal construction, featuring a cast Aluminum center wall, is designed to withstand harsh industrial environments.

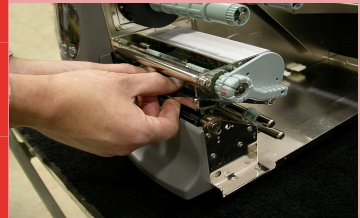

Remove the Printhead assembly by pulling it towards you as shown.

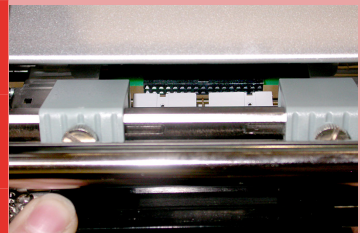

Line up the plug and side guides of the Printhead assembly and insert the new Printhead into its carriage to complete the exchange.



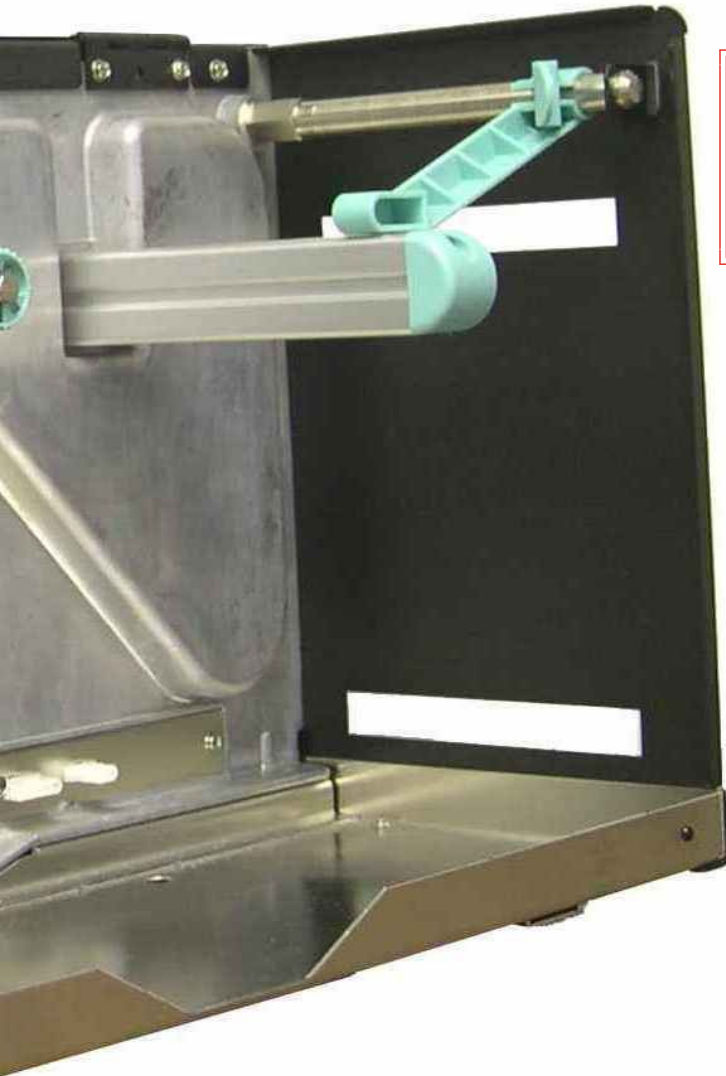

The Optional Applicator Interface provides a means of communications between an applicator and the H-400/H-600 Series.





PRODUCT OVERVIEW

Whether you want to tear, cut, rewind, strip-and-peel or print-and-apply the H-400/H-600 Series printers have accessories for every application that are elegantly designed, easy to install, and offered at very affordable prices.

H-400 Series/H-600 Series Printers

| | | |
|---|------|---|
|  | H427 | H-427 4.09" (104mm) wide 203 dpi (8 dot/mm) 7" (177.8mm)per second |
|  | H436 | H-436 4.16" (105.7mm) wide 300 dpi (12 dot/mm) 6" (152.4mm)per second |
|  | H626 | H-626 6.61" (168mm) wide 203 dpi (8 dot/mm) 6" (152.4mm)per second |
|  | H634 | H-634 6.61" (168mm) wide 300 dpi (12 dot/mm) 4" (101.6mm)per second |

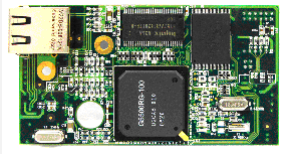
Optional Interfaces

| | | |
|---|---|---|
|  | Wired 033-12P019-060 Wireless 033-12P018-060 | Wired Ethernet Interface/ Wireless Ethernet Interface Provides networking capability to the H-400/H-600 Series printers. |
|  | 033-22P001-060 | Applicator Interface Provides a means of communications between an applicator and the H-400/H-600 Series printers. |

Accessories

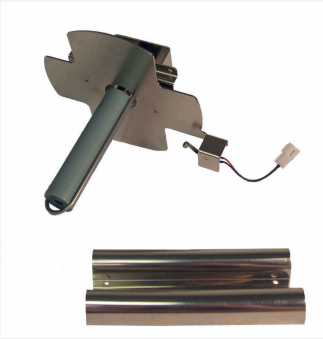

Internal Rewind (H-400 Series)

033-22P004-060 Can be used for winding used label liner when dispensing labels or for winding labels as they are printed.



Internal Rewind with Stripper Sensor (H-600 Series)

033-62P002-060 Can be used for winding used label liner when dispensing labels with the Stripper Sensor or for winding labels as they are printed.



Cutter (H-400 Series)

033-22P005-060 You can cut labels or tag stock between labels, after batches of labels, or at the end of a job.



Heavy Duty Cutter (H-600 Series)

033-62P004-061 You can cut labels or tag stock or foil between labels, after batches of labels, or at the end of a job.

Tharo Applicators

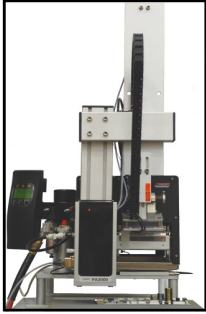

PA2000 Applicator

A small footprint applicator available in Tamp or Tamp/ Blow configurations. The PA2000 features a remote front panel for easy access regardless of the orientation.

Can be set up to apply labels on either the top or side of a product. In the Tamp-Blow configuration the PA2000 has the ability to apply labels to convex, concave or flat surfaces.

A Specialty Tamp Option (H-427 or H-436 only) is available for very small, delicate, high precision print and apply applications like electronic components, PC boards, cosmetics, pharmaceuticals and assemblies.



PA1200 Applicator Dual Tamp / Front Apply

For specialty applications requiring a label to be applied to the front and/or top of a product or the side and/or top of a Product.



PA1200 Applicator Corner Wrap

For specialty applications requiring a label to wrap-around a corner.

Can be set up to wrap onto either the top or side of a product.

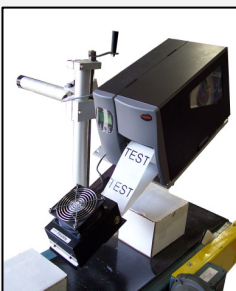



PA500w Applicator

The compact PA500w is fast and simple to operate. You can quickly setup and changeover the PA500w for top apply or side apply.

The PA500w also integrates easily into existing production lines and packaging systems.

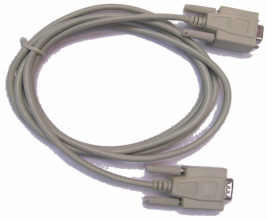
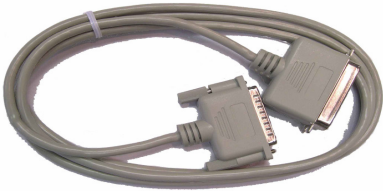
Cables

| | |
|---|---|
|  | <p>8000401 Serial Cable</p> |
|  | <p>10410 Parallel Cable</p> |
|  | <p>USB2AB USB Cable</p> |

Spare Parts

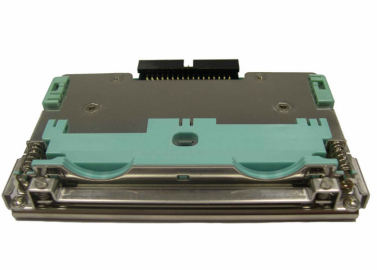
| | |
|---|---|
|  | <p>023-22P005-060TH Printhead H-427 203 dpi</p> |
| | <p>023-23P001-060TH Printhead H-436 300 dpi</p> |
| | <p>023-62P001-060 Printhead H-626 203 dpi</p> |
| | <p>023-63P001-060 Printhead H-634 300 dpi</p> |

| | |
|---|---|
|  | <p>023-22P009-060 Drive Roller H-400 Series</p> |
| | <p>023-62P014-060 Drive Roller H-600 Series</p> |

H-400 Series Specifications

| Model | H - 427 | H - 436 |
|---------------------------|---|--------------------------------|
| Resolution | 203 dpi (8 dot/mm) | 300 dpi (12 dot/mm) |
| Print Mode | Thermal Transfer / Direct Thermal | |
| CPU | 32 Bit | |
| Memory | 4MB Flash, 16MB SDRAM | |
| Print Speed | 50.8mm (2") ~ 177.8mm (7")/sec | 50.8mm (2") ~ 152.4mm (6")/sec |
| Print Length | 5mm (0.20") ~ 4572mm (180") | 5mm (0.20") ~ 2159mm (85") |
| Print Width | 13mm (0.51") ~ 104mm (4.09") | 13mm (0.51") ~ 105.7mm (4.16") |
| Sensor Type | Moveable transmissive sensor and reflective sensor; left aligned | |
| Sensor Detection | Type: Label gap and black mark sensing Detection: Label length auto sensing and/or program command setting | |
| Media | Label Roll: Max. 203mm (8.0") Core Diameter: 38.1mm (1.5") ~ 76.2mm (3") Width: 25.4mm (1") ~ 118.00mm (4.64") Thickness: 0.06mm (0.002") ~ 0.25mm (0.009") | |
| Ribbon | Length: 450m (1471') Type: Ink inside or ink outside thermal transfer ribbons (wax, resin and wax/resin) in widths of 30 to 110mm (1.18" to 4.33"). Core inner diameter 25.4mm (1"). Maximum ribbon roll diameter 76mm (2.99"). | |
| Printer Language | TPL (Tharo Programming Language) | |
| Software | EASYLABEL [®] Start Microsoft Windows Drivers, CUPS (Common UNIX Printing System) Driver | |
| Resident Fonts | 11 resident alphanumeric fonts (including OCR A & B), are expandable eight times horizontally and vertically. Scalable Font (Code Page 850 & 852) | |
| Downloadable Fonts | Windows Bit-map fonts, TrueType fonts and Asian fonts | |
| Image Handling | BMP and PCX | |
| Bar Codes | Code 39, Code 93, Code 128 (subsets A, B, C), UCC/EAN-128, UPC-A, UPC-E, UPC and EAN 2 or 5 digit extensions, I 2 of 5, EAN-8, EAN-13, Codabar, Postnet, DUN 14, MaxiCode, Plessey, Telepen, FIM, China Postal Code, RPS 128, PDF417, Data Matrix & QR Code | |
| Interfaces | RS-232 Serial (Baud rate 4800 ~ 115200, XON/XOFF, DSR/DTR) USB (2.0) CompactFlash card slot Parallel PS/2 Keyboard Port | |
| Control Panel | Backlit LCD Display: 128 dot x 64 dot Graphical LCD Three single-color LEDs: Power, Ready, Error Three Control Keys: Feed, Pause, Cancel | |
| Power | Auto Switching 110/240VAC, 50/60 Hz | |
| Real Time Clock | Standard | |
| Environment | Operation: 32° F to 104° F (0° C to 40° C)* Storage: -40° F to 122° F (-20° C to 50° C) | |
| Humidity | Operation: 30-85%, non-condensing. Free air. Storage: 10-90%, non-condensing. Free air. | |
| Printer Dimensions | Length: 512mm (20.15") Height: 291mm (11.45") Width: 274mm (10.78") Weight: about 15Kg (33.1 lbs) | |
| Options | Cutter Internal Rewind Wired Ethernet Interface or Wireless Ethernet Interface Applicator Interface PA2000, PA1200 or PA500w Applicator EASYLABEL Silver, Gold, Platinum or Multi-User | |

*An increase in print darkness may be required below 41° F (5° C)
Specifications are subject to change without notice.

All brand or product names are trademarks or registered trademarks of their respective companies.

H-600 Series Specifications

| Model | H - 626 | H - 634 |
|---------------------------|---|--------------------------------|
| Resolution | 203 dpi (8 dot/mm) | 300 dpi (12 dot/mm) |
| Print Mode | Thermal Transfer / Direct Thermal | |
| CPU | 32 Bit | |
| Memory | 4MB Flash, 16MB SDRAM | |
| Print Speed | 50.8mm (2") ~ 152.4mm (6")/sec | 50.8mm (2") ~ 101.6mm (4")/sec |
| Print Length | 13mm (0.51") ~ 2997.2mm (118") | 13mm (0.51") ~ 1371.6mm (54") |
| Print Width | 50.8mm (2") ~ 168mm (6.61") | |
| Sensor Type | Moveable transmissive sensor and reflective sensor; left aligned | |
| Sensor Detection | Type: Label gap and black mark sensing Detection: Label length auto sensing and/or program command setting | |
| Media | Label Roll: Max. 203mm (8.0") Core Diameter: 38.1mm (1.5") ~ 76.2mm (3") Width: 50.8mm (2") ~ 178.00mm (7") Thickness: 0.06mm (0.002") ~ 0.25mm (0.009") | |
| Ribbon | Length: 450m (1471') Type: Ink inside or ink outside thermal transfer ribbons (wax, resin and wax/resin) in widths of 60 to 174mm (2.36" to 6.85"). Core inner diameter 25.4mm (1"). Maximum ribbon roll diameter 76mm (2.99"). | |
| Printer Language | TPL (Tharo Programming Language) | |
| Software | EASYLABEL ® Start Microsoft Windows Drivers, CUPS (Common UNIX Printing System) Driver | |
| Resident Fonts | 11 resident alphanumeric fonts (including OCR A & B), are expandable eight times horizontally and vertically. Scalable Font (Code Page 850 & 852) | |
| Downloadable Fonts | Windows Bit-map fonts, TrueType fonts and Asian fonts | |
| Image Handling | BMP and PCX | |
| Bar Codes | Code 39, Code 93, Code 128 (subsets A, B, C), UCC/EAN-128, UPC-A, UPC-E, UPC and EAN 2 or 5 digit extensions, I 2 of 5, EAN-8, EAN-13, Codabar, Postnet, DUN 14, MaxiCode, Plessey, Telepen, FIM, China Postal Code, RPS 128, PDF417, Data Matrix & QR Code | |
| Interfaces | RS-232 Serial (Baud rate 4800 ~ 115200, XON/XOFF, DSR/DTR) USB(2.0) CompactFlash card slot Parallel PS/2 Keyboard Port | |
| Control Panel | Backlit LCD Display: 128 dot x 64 dot Graphical LCD Three single-color LEDs: Power, Ready, Error Three Control Keys: Feed, Pause, Cancel | |
| Power | Auto Switching 110/240VAC, 50/60 Hz | |
| Real Time Clock | Standard | |
| Environment | Operation: 32° F to 104° F (0° C to 40° C)* Storage: -40° F to 122° F (-20° C to 50° C) | |
| Humidity | Operation: 30-85%, non-condensing. Free air. Storage: 10-90%, non-condensing. Free air. | |
| Printer Dimensions | Length: 516mm (20.31") Height: 285mm (11.22") Width: 345mm (13.58") Weight: about 16.6Kg (36.6 lbs) | |
| Options | Heavy-Duty Cutter Internal Rewind with Stripper Sensor Wired Ethernet Interface or Wireless Ethernet Interface Applicator Interface PA2000 Applicator EASYLABEL Silver, Gold, Platinum or Multi-User | |

*An increase in print darkness may be required below 41° F (5° C)

Specifications are subject to change without notice.

All brand or product names are trademarks or registered trademarks of their respective companies.



THARO SYSTEMS

PO Box 798 • Brunswick, Ohio • 44212-0798 •
USA

(800) 878-6833 • (330) 273-4408

FAX: (330) 225-0099

<http://www.tharo.com> • tharo@tharo.com

Distributed By: