

Status: 11/2018



Products need labeling
Label printers
for industrial applications



SQUIX
Made in Germany

Contents

- 3** SQUIX label printers for industrial applications
- 4 - 5** Industrial printers with a left-aligned material guide
- 6 - 7** Label printers with a centered material guide
- 8** Operation panel
- 9** Print heads, print rollers, interfaces
- 10 - 11** Technical data
- 12 - 13** Label software cablabel S3
 - Printing in stand-alone operation
 - Printer control and administration
- 14 - 17** Accessories
- 18 - 19** Applicator S1000
- 20** Applicator S3200
 - Demand modules
- 21** All-around labeler
 - Mounting equipment
- 22** Label printers with special covers or protection chassis
- 23** Maintenance, services, training
- 24 - 26** Delivery program

Scopes of delivery, design and technical specifications correspond to the date of the printing.
Subject to change. The data provided in the catalog do not represent any warranty or guarantee.



Information is also
available on the Internet:
www.cab.de/en/squix



SQUIX

Label printers for industrial applications

The professional **SQUIX** label printers are the further development of the successful A⁺ printer series. They fit with a wide range of industrial applications. They have been developed with focus on easy and convenient operation and high reliability.

The print mechanics and the chassis are made of high-quality materials and perfectly match in terms of shape and function. A large number of peripherals and software enable customer-specific solutions.

Whether they are operated in stand-alone mode, in a PC application or within a network - the rugged SQUIX printers are always up to the mark. The high-speed processor ensures fast job processing and immediately provides the required label.

- innovative technology
- easy operation
- accurate imprint
- reliable and fast printing
- compact, appealing design
- highest quality standards

Sample applications:

PCB labels

When only little space is available
– smallest label size 4 x 3 mm

Type plates

Pin sharp fonts, graphics and barcodes
up to 600 dpi

Cardboard box and pallet labels

up to A5 size



Industrial printers



Material guide
left-aligned



1.1 The slim one

for small labels when little footprint is available

| Label printer | | SQUIX 2 | |
|----------------------|------------|---------|------|
| Printable resolution | dpi | 300 | 600 |
| Print speed | up to mm/s | 250 | 150 |
| Print width | up to mm | 56.9 | 54.1 |



1.2 The universal one

The best-selling industrial device with a wide range of accessories.

| Label printer | | SQUIX 4.3 | | SQUIX 4 | |
|----------------------|------------|-----------|-------|---------|-------|
| Printable resolution | dpi | 203 | 300 | 300 | 600 |
| Print speed | up to mm/s | 250 | 250 | 300 | 150 |
| Print width | up to mm | 104 | 108.4 | 105.7 | 105.7 |



1.3 The wide one

for Odette and UCC labels in applications in logistics

| Label printer | | SQUIX 6.3 | |
|----------------------|------------|-----------|-------|
| Printable resolution | dpi | 203 | 300 |
| Print speed | up to mm/s | 250 | 250 |
| Print width | up to mm | 168 | 162.6 |



Basic versions

for printing on labels and continuous materials that are wound on rolls or fanfold. The material is separated at the jagged tear-off edge. Optionally, it can be cut or externally rewound.



Peel-off versions P

In addition to the basic version the labels can also be dispensed. The label is separated from the carrier material after the printing. It can be removed manually or by an applicator. Delivery includes I/O interface



The extra wide one

for pallet and barrel labels

| Label printer | | A8 ⁺ |
|----------------------|------------|-----------------|
| Printable resolution | dpi | 300 |
| Print speed | up to mm/s | 150 |
| Print width | up to mm | 216 |

For further information on the A8⁺ see
www.cab.de/en/a8plus

Details



Label printer
SQIX 4 P

1 Hinged cover

The two-part cover made of impact-proof plastics folds when it is opened. Therefore, only little footprint is needed. The large panoramic window enables to check the material consumption and to track the full printing process.

2 Plungers

One plunger is fixed at the inner side. The second one is adjusted that far to the edge of the label until a good print image is ensured.

3 Rugged metal chassis

made of cast aluminum; basis to assemble all components

4 Print rollers' coating

Synthetic rubber is standard for accurate imprint; silicone is available as an option for an extra long service life at a higher imprint tolerance

5 Peel-off function

Via the peel-off plate, the label is separated from the carrier material. Accurate imprint and dispense are achieved with the powered rewind assist roller and the pinch roller.

6 Periphery connection

Additional modules are easy to connect. All peripheral devices are plugged to the printer with two pins and fixed with a screw.

7 Ribbon holder

Fast and easy exchange of the ribbon is enabled with the three-part tightening axles.

8 Roll holder

The spring-mounted margin stop with a screw cap enables constant tension during material feed and therefore improves accurate imprint. If rolls with 100 mm core diameter are processed, an adapter is recommended.

9 Internal rewinder

Peel-off versions allow to rewind labels or carrier materials with or without a cardboard core. The three-part tightening axle provides easy material handling.

10 Rocker

When printing is started, the spring-mounted rocker with pulleys made of Teflon dampens the tension and therefore improves accurate imprint.

11 Material guide

It is mounted on the rocker. The stop is adjusted to the edge of the label with the rotary knob.

Label printers M series



Material guide centered



Basic version



Peel-off version P

1.4 The accurate and versatile one

for printing on all materials that are wound on rolls or reels or fanfold - especially very small labels or slim continuous materials such as pressed shrink tubes.

As regards the label width, no adjustment of the plungers is needed.

Width-adapted print rollers are provided for slim materials.

| Label printer | | SQUIX 4.3 M | | SQUIX 4 M | |
|----------------------|------------|-------------|-------|-----------|-------|
| Printable resolution | dpi | 203 | 300 | 300 | 600 |
| Print speed | up to mm/s | 250 | 250 | 300 | 150 |
| Print width | up to mm | 104 | 108.4 | 105.7 | 105.7 |

Differences compared to a left-aligned material guide

1 Ribbon holder

Easy insertion of the ribbons is enabled with the three-part tightening axles. A preprinted ruler simplifies the adjustment.

2 Roll holder

When setting the margin stop, the material roll is automatically centered. If rolls with 100 mm core diameter are processed, an adapter is recommended.

3 Plungers

Both plungers are fixed for all material widths. No print head settings or adjustments are necessary.

4 Material guide

The material guide just in front of the print roller provides accurate imprint. The material width is adjusted with a spindle.

5 Print rollers' coating

Synthetic rubber is standard for accurate imprint; silicone is available as an option for an extra long service life at a higher imprint tolerance

6 Slim print rollers

In order to achieve accurate imprint with slim materials and ribbons, also slim print rollers are needed. These prevent from print roller wear, print head contamination and errors during material feed. Coating: synthetic rubber



Label printer SQUIX 4 MP



Label printers MT series



**Material guide
centered
with separator**



1.5 The textile printer

It is also possible to print on labels or continuous materials that are wound on rolls or reels.

As regards the label width, no adjustment of the plungers is needed.

Width-adapted print rollers are provided for slim materials.

| Label printer | | SQUIX 4.3 MT | SQUIX 4 MT | |
|----------------------|------------|--------------|------------|-------|
| Printable resolution | dpi | 300 | 300 | 600 |
| Print speed | up to mm/s | 250 | 300 | 150 |
| Print width | up to mm | 108.4 | 105.7 | 105.7 |

Differences compared to a left-aligned material guide

1 Ribbon holder

Easy insertion of the ribbons is enabled with the three-part tightening axles. A preprinted ruler simplifies the adjustment.

2 Roll holder

When setting the margin stop, the material roll is automatically centered. If rolls with 100 mm core diameter are processed, an adapter is recommended.

3 Plungers

Both plungers are fixed for all material widths. No print head settings or adjustments are necessary.

4 Antistatic brush

Particularly with plastic materials the electrostatic charge is discharged after printing.

5 Separator

At high heat energy the ribbon can stick with the textile tape. A roller reliably separates the material from the ribbon.

6 Material guide

The material guide just in front of the print roller provides accurate imprint. The material width is adjusted with a spindle.

7 Print rollers' coating

Synthetic rubber is standard for accurate imprint; silicone is available as an option for an extra long service life at a higher imprint tolerance

8 Slim print rollers

In order to achieve accurate imprint with slim materials and ribbons, also slim print rollers are needed. These prevent from print roller wear, print head contamination and errors during material feed. Coating: synthetic rubber

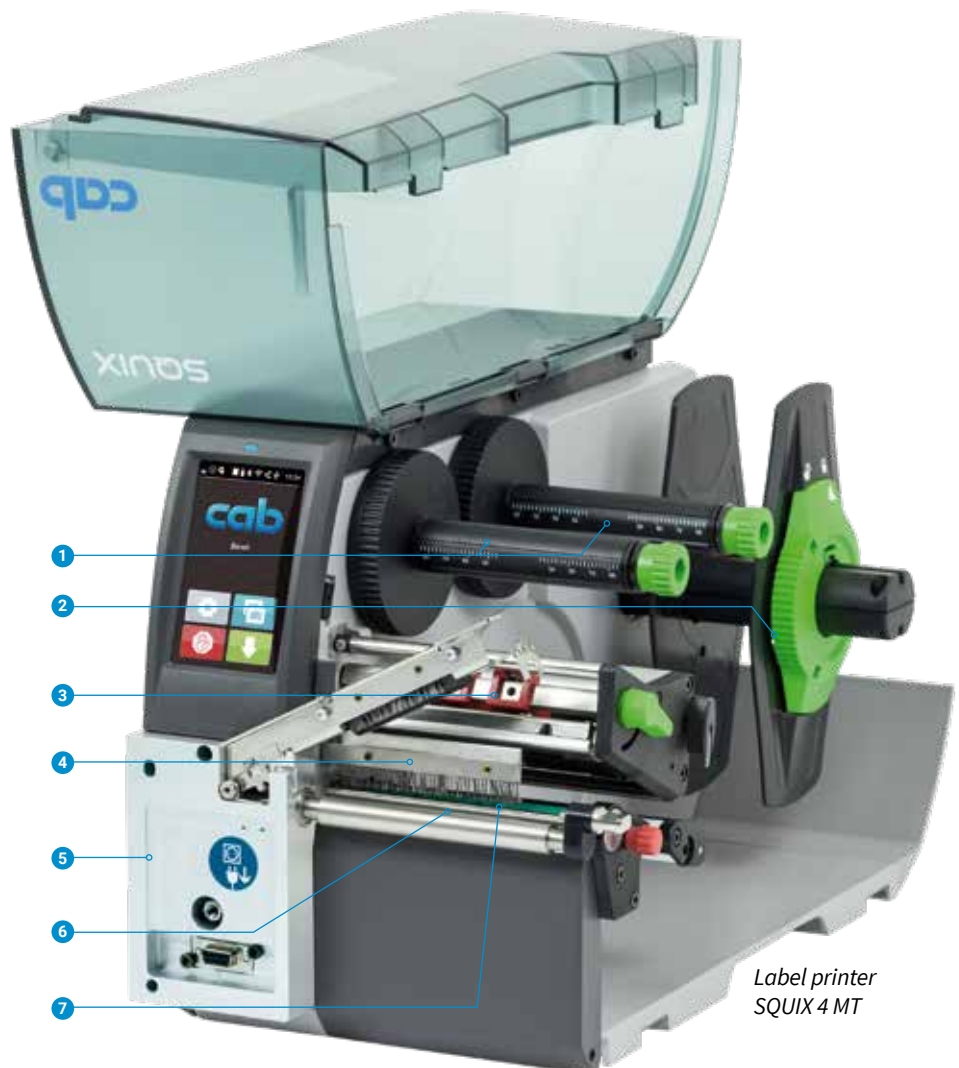

Label printer
SQUIX 4 MT

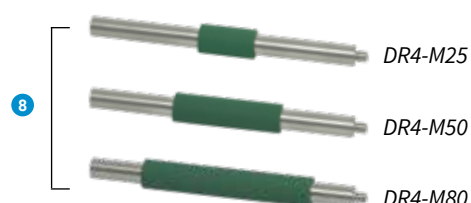





Operation panel

Intuitive and easy operation with self-explanatory symbols to configure the device setups

- 1 **LED signal:** Power ON
- 2 **Status bar:** Data reception, Record data stream, Ribbon pre-warning, SD memory card / USB memory stick plugged in, Bluetooth, WLAN, Ethernet, USB Slave, Time
- 3 **Printer status:** Ready, Pause, Number of printed labels per print job, Label in peel-off position, Awaiting external start signal
- 4 **Periphery buttons**

| | |
|----------------------------|---------------------------|
| Cutter/perforation cutter: | direct cutting |
| External rewinder: | winding outside or inside |
| Tear-off or peel-off mode: | print the next label |
| Applicator: | label application |
- 5 **Operation**

| | | | |
|---|----------------------------------|---|--------------------------------|
|  | Jump to menu |  | Stop and delete all print jobs |
|  | Reprint last label |  | Label feed |
|  | Interrupt and continue print job | | |
- 6 **USB slot** for the Service Key or a memory stick, to load data in the IFFS storage
- 7 **USB WLAN stick** 2.4 GHz 802.11b/g/n included as an extra item in the scope of delivery; In hotspot mode it is possible to directly connect a mobile device with the printer via WLAN.



Setup options



Printing parameters



Print position Y
Fast setup with a slider,
fine setup with ± keys

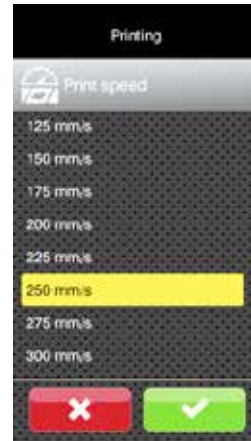

Print speed selection
via scroll function



Video tutorials
Scan QR code with a
mobile device and watch
the explanatory video

Print heads



All print heads are freely interchangeable at equal width. They are automatically detected and calibrated by the CPU.

Major data such as running performance, maximum operating temperature and heat energy are directly stored in the print head. The data can be read at the plant.

Print heads for SQUIX 2, SQUIX 4 - 300, 600 dpi

for a sharp-edge print image
for type plates with small fonts, graphics
and material marking with high energy needs

Print heads for SQUIX 4.3, SQUIX 6.3 - 203, 300 dpi

durable, for rough surroundings and thermal direct printing

Print rollers in two types of material



Print rollers DR

Coating: synthetic rubber
They are suited for accurate imprint and provided as standard.

Print rollers DRS

Coating: silicone
They have an extra long service life at a higher imprint tolerance.

Interfaces on the back of the device



1 Slot for SD memory card

2 2 x USB host interfaces to connect a Service Key, USB memory stick, keyboard, barcode scanner, USB Bluetooth adapter, USB WLAN stick

3 USB 2.0 Hi-speed device to connect a PC

4 Ethernet 10/100 BASE-T

5 RS232C interface 1,200 to 230,400 baud/8 bit

6 3.1 I/O interface standard with peel-off devices, accessory to basic devices Labeling is started with a PLC, a sensor or a hand switch. At the same time, status and error messages are issued.

Compliant with IEC/EN 61131-2, type 1+3; all inputs and outputs are galvanically isolated and protected from reverse polarity. In addition, outputs are short circuit protected.

Inputs PNP

Start print and apply
Print first label
Reprint
Delete print job
Label dispensed
Interrupt labeling
Pause
Reset

Outputs PNP; NPN on request

Printer/periphery ready
Print job available
Applicator in initial position
Paper feed ON
Label in peel-off position
Applicator in apply position
Ribbon pre-warning
Common error

Technical data

● Typical ○ Possible ■ Standard □ Option

| | | 1.1 | | 1.2 | | | 1.3 | | 1.4 | | | 1.5 | | | | | | |
|---|---|------------------------|------|----------------------------|-------|---------|-------------|-----------|-------------|-------------|-------|-------------|-------|--------------|-------|------------|-------|---|
| Label printer | | SQUIX 2 | | SQUIX 4.3 | | SQUIX 4 | | SQUIX 6.3 | | SQUIX 4.3 M | | SQUIX 4 M | | SQUIX 4.3 MT | | SQUIX 4 MT | | |
| Material feed | | left-aligned | | | | | | | | | | | | | | | | |
| Printing method | Thermal transfer | ● | ● | ● | ● | ● | ● | ● | ● | ● | ● | ● | ● | ● | ● | ● | ● | ● |
| | Thermal direct | ○ | - | ● | ● | ○ | - | ● | ● | ● | ● | ○ | - | ● | ○ | - | ○ | - |
| Printable resolution | dpi | 300 | 600 | 203 | 300 | 300 | 600 | 203 | 300 | 203 | 300 | 300 | 600 | 300 | 600 | 300 | 600 | |
| Print speed | up to mm/s | 250 | 150 | 250 | 250 | 300 | 150 | 250 | 250 | 250 | 250 | 300 | 150 | 250 | 300 | 150 | 150 | |
| Print width | up to mm | 56.9 | 54.1 | 104 | 108.4 | 105.7 | 105.7 | 168 | 162.6 | 104 | 108.4 | 105.7 | 105.7 | 108.4 | 105.7 | 105.7 | 105.7 | |
| Print start | Distance to locating edge | mm | | 2 | 2.8 | 1.2 | 2 | 0.5 | 3.2 | centered | | | | | | | | |
| Material | | | | | | | | | | | | | | | | | | |
| Roll, fanfold, reel (reel only with centered devices) | Paper, cardboard, PET, PE, PP, PI, PVC, PU, acrylate, Tyvec | ● | | ● | | | ● | | ● | | | ● | | ● | | | | |
| | Smart Labels | - | | ● | | | ● | | ● | | | ● | | ○ | | | | |
| | Ready-for-use shrink tubes | - | | ○ | | | ○ | | ○ | | | ● | | ○ | | | | |
| | Pressed continuous shrink tubes | - | | - | | | - | | - | | | ● | | ○ | | | | |
| | Textile tapes | - | | - | | | - | | - | | | ○ | | ● | | | | |
| Labels ¹⁾ | Width | mm | | 4-63 | | 20-116 | | | 46-176 | | 4-110 | | | 4-110 | | | | |
| | Height without label backfeed ²⁾ | from mm | | 4 | | 4 | | | 6 | | 3 | | | 4 | | | | |
| | with label backfeed ²⁾ | from mm | | 4 | | 6 | | | 12 | | 4 | | | 6 | | | | |
| | with label backfeed when dispensing | from mm | | 6 | | 6 | | | 12 | | 6 | | | - | | | | |
| | Maximum height | mm | | 2,000 | | | | | | | | | | | | | | |
| Carrier material | Thickness | mm | | 0.03-0.60 | | | | | | | | | | | | | | |
| | Width | mm | | 24-67 | | 24-120 | | | 50-180 | | 9-114 | | | 9-114 | | | | |
| Continuous material | Thickness | mm | | 0.03-0.16 | | | | | | | | | | | | | | |
| | Width | mm | | 24-67 | | 24-120 | | | 50-180 | | 9-114 | | | 9-114 | | | | |
| | Thickness | mm | | 0.05-0.50 | | | | | | | | | | | | | | |
| Shrink tubes | Weight (cardboard) | up to g/m ² | | 300 | | | | | | | | | | | | | | |
| | Width ready-for-use | up to mm | | - | | 120 | | | - | | 114 | | | 114 | | | | |
| | Width continuous | mm | | - | | - | | | - | | 4-85 | | | 4-85 | | | | |
| | Thickness | up to mm | | - | | 1.1 | | | - | | 1.1 | | | 1.1 | | | | |
| Roll, reel | Outside diameter with core diameter | mm | | 205 / 38.1-76 180 / 100 | | | | | | | | | | | | | | |
| | Winding | outside or inside | | | | | | | | | | | | | | | | |
| Ribbon³⁾ | | | | | | | | | | | | | | | | | | |
| Ink side | outside or inside | | | | | | | | | | | | | | | | | |
| Roll diameter | up to mm | 80 | | | | | | | | | | | | | | | | |
| Core diameter | mm | 25.4 | | | | | | | | | | | | | | | | |
| Variable length | up to m | 450 | | | | | | | | | | | | | | | | |
| Width | mm | 25-57 | | 25-114 | | | 50-170 | | 25-114 | | | 25-114 | | | | | | |
| Internal rewinder in peel-off version | | | | | | | | | | | | | | | | | | |
| Outside diameter | up to mm | 142 | | | | | | | | | | | | | | - | | |
| Core diameter | mm | 38.1-40 | | | | | | | | | | | | | | - | | |
| Winding | outside | | | | | | | | | | | | | | | | - | |
| Printer sizes and weights | | | | | | | | | | | | | | | | | | |
| Width x Height x Depth | mm | 200x288x460 | | 252x288x460 | | | 312x288x460 | | 252x288x460 | | | 252x288x460 | | | | | | |
| Weight | kg | 9 | | 10 | | | 14 | | 10 | | | 10 | | | | | | |
| Label sensor with position indication | | | | | | | | | | | | | | | | | | |
| Gap sensor for | labels, punch marks or print marks in transparent materials and end of material | | | | | | | | | | | | | | | | | |
| Reflective sensor from below or top for | print marks in not transparent materials and end of material | | | | | | | | | | | | | | | | | |
| Distance sensor | to locating edge | left-aligned | mm | 5-26 | | 5-60 | | | 5-60 | | - | | | - | | | | |
| | from center to locating edge | centered | mm | - | | - | | | - | | 0-55 | | | 0-55 | | | | |
| Height of material gap | up to mm | 2 | | | | | | | | | | | | | | | | |
| Electronics | | | | | | | | | | | | | | | | | | |
| Processor 32 bit clock rate | MHz | 800 | | | | | | | | | | | | | | | | |
| Main storage (RAM) | MB | 256 | | | | | | | | | | | | | | | | |
| Data storage (IFFS) | MB | 50 | | | | | | | | | | | | | | | | |
| Slot for SD memory card (SDHC, SDXC) | up to GB | 512 | | | | | | | | | | | | | | | | |
| Battery for time and date, real-time clock | ■ | | | | | | | | | | | | | | | | | |
| Data storage when power is off (e.g. serial numbers) | ■ | | | | | | | | | | | | | | | | | |
| USB WLAN stick 2.4 GHz 802.11b/g/n | ■ (included as an extra item in the scope of delivery) | | | | | | | | | | | | | | | | | |
| Interfaces | | | | | | | | | | | | | | | | | | |
| RS232C 1,200 to 230,400 baud/8 bit | ■ | | | | | | | | | | | | | | | | | |
| USB 2.0 Hi-speed device to connect a PC | ■ | | | | | | | | | | | | | | | | | |
| Ethernet 10/100 BASE-T | LPD, IPv4, RawIP printing, DHCP, HTTP/HTTPS, FTP/FTPS, SMTP, SNMP, TIME, NTP, Zeroconf, SOAP web service, VNC | | | | | | | | | | | | | | | | | |
| 1 x USB host at the operation panel for | Service Key or USB memory stick | | | | | | | | | | | | | | | | | |
| 1 x USB host at the operation panel for | USB WLAN stick 2.4 GHz 802.11b/g/n | | | | | | | | | | | | | | | | | |
| 2 x USB host on the back side for | Service Key, USB memory stick, keyboard, barcode scanner, USB Bluetooth adapter, USB WLAN stick | | | | | | | | | | | | | | | | | |
| WLAN 802.11b/g/n, hotspot or infrastructure mode | GHz | 2.4 ■ / 5 □ | | | | | | | | | | | | | | | | |
| Periphery connection USB host, 24 VDC | ■ | | | | | | | | | | | | | | | | | |
| Digital I/O with 8 inputs and outputs | Peel-off/basic device | ■/□ | | | | | | | | | | | | | | | | |

¹⁾ Limitations may apply to small labels, thin materials or strong adhesives. Critical applications need to be tested.

²⁾ when tearing off, cutting, rewinding

³⁾ The ribbon should at least correspond with the width of the carrier material.

Technical data

■ Standard □ Option

| Operating data | | |
|--|--|--|
| Power supply | 100 - 240 VAC, 50/60 Hz, PFC | |
| Power consumption | Standby <10 W / typical 150 W / maximum 300 W | |
| Temperature / humidity | Operation | +5 - 40°C / 10 - 85 % not condensing |
| | Storage | 0 - 60°C / 20 - 85 % not condensing |
| | Transport | -25 - 60°C / 20 - 85 % not condensing |
| Approvals | CE, FCC, CB, cULus, CCC | |
| Operation panel | | |
| | Touchscreen LCD color display | |
| Screen diagonal | 4.3" | |
| Resolution pixels W x H | 272 x 480 | |
| Setup options | | |
| | Print Labels Ribbon Tear-off Peel-off Cut Apply Interfaces Error | Region: Language Country Keyboard Time zone Time Display: Brightness Power save mode Orientation Interpreter |
| Status bar | | |
| | Data reception Record data stream Ribbon pre-warning SD memory card plugged in USB memory stick plugged in | Bluetooth WLAN Ethernet USB Slave Time |
| Monitoring | | |
| | Ribbon pre-warning End of ribbon End of material Periphery error | Print head tension Print head temperature Print head open Pinch roller open (with peel-off version and separator) |
| Test routines | | |
| System diagnostics | when device is switched on, including print head detection | |
| Information display, test printout, analysis | Status printout Fonts list Type overview WLAN status | Test grid Label profile List of events Monitor mode |
| Status reports | - Printout of system settings, for example print lengths and running times - System status request via software command - Display information of, for example, network error, missing link, barcode error, periphery error, etc. | |
| Fonts | | |
| Font types internally provided | 5 bitmap fonts: 12 x 12 dots 16 x 16 dots 16 x 32 dots OCR-A OCR-B | 7 vector fonts: AR Heiti Medium GB-Mono CG Triumvirate Condensed Bold Garuda HanWangHeiLight Monospace 821 Swiss 721 Swiss 721 Bold |
| to be stored | TrueType fonts | |
| Character sets | Windows-1250 to -1257 DOS 437, 737, 775, 850, 852, 857, 862, 864, 866, 869 EBCDIC 500 ISO 8859-1 to -10 and -13 to -16 WinOEM 720 UTF-8 MacRoman DEC MCS KOI8-R Western European Eastern European Chinese simplified Chinese traditional Thai | |
| | | Cyrillic Greek Latin Hebrew Arabic |

| Fonts | | |
|--|--|--|
| Bitmap fonts | Size in width and height 1 - 3 mm Zoom factor 2 to 10 Orientations 0°, 90°, 180°, 270° | |
| Vector / TrueType fonts | Size in width and height 0.9 - 128 mm Variable zoom Orientation 360° in steps of 1° | |
| Font styles | Bold, italic, underlined, outline, inverse - depending from the font type | |
| Character spacing | Variable or Monospace for fixed character spacings | |
| Graphics | | |
| Graphic elements | Lines, arrows, rectangles, circles, ellipses - filled and filled with fading | |
| Graphic formats | PCX, IMG, BMP, TIF, MAC, GIF, PNG | |
| Barcodes | | |
| Linear | Code 39, Code 93 Code 39 Full ASCII Code 128 A, B, C EAN 8, 13 EAN/UCC 128/GS1-128 EAN/UPC Appendix 2 EAN/UPC Appendix 5 FIM HIBC | Interleaved 2/5 Ident- and routing code of Deutsche Post Codabar JAN 8, 13 MSI Plessey Postnet RSS 14 UPC A, E, E0 |
| 2D and stacked | DataMatrix DataMatrix Rectangle Extension QR code Micro CR code GS1 QR code GS1 DataMatrix PDF 417 Micro PDF 417 UPS MaxiCode GS1 DataBar Aztec Codablock F RSS 14 truncated, limited, stacked, stacked omni-directional | |
| | All codes are variable as regards height, modular width and ratio; orientations 0°, 90°, 180°, 270° optional check digit, plain text printout and start / stop code depending on the type of code | |
| Software | | |
| Label software | cablabel S3 Lite cablabel S3 Viewer cablabel S3 Pro cablabel S3 Print | ■ ■ □ □ |
| Running also with | CODESOFT NiceLabel EASYLABEL BarTender | |
| Stand-alone operation | ■ | |
| WHQL certified Windows printer drivers for | Windows Vista Windows 7 Windows 8 Windows 8.1 Windows 10 | Server 2008 Server 2008 R2 Server 2012 Server 2012 R2 Server 2016 |
| Apple Mac OS X printer drivers | from version 10.6 | |
| Linux printer drivers | from CUPS 1.2 | |
| Programming | Printer language JScript abc Basic Compiler | |
| Integration | SAP Database Connector | |
| Administration | Printer control Configuration in Intranet and Internet Network Manager (in preparation) | |

Label software cablabel S3

Designing, printing, administrating with cablabel S3

cablabel S3 opens up the full potential of cab devices.

First of all, the label must be designed. Only when it comes to printing it has to be decided whether the label shall be processed on a label printer, a print and apply or marking laser system.

cablabel S3 is of a modular design which makes it adaptable to requirements step by step. To support functions like native JScript programming, elements such as the JScript Viewer are embedded as plug-ins. The designer user interface and the JScript code are synchronized in real time. Special functions like the Database Connector or barcode testers can be integrated.

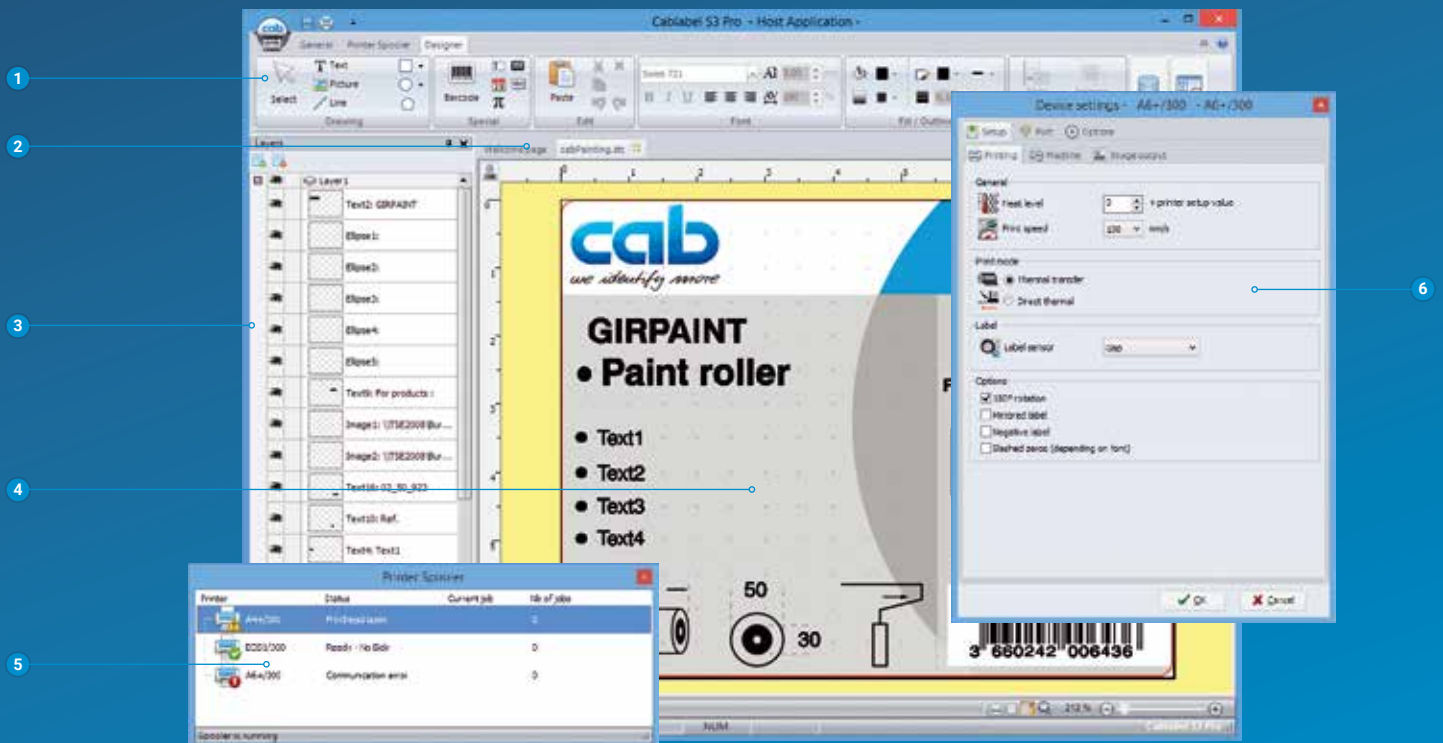

- 1 **Toolbar**
to create different label objects
- 2 **Tabs**
to quickly switch from one running label design to another
- 3 **Layers**
to administrate different label objects
- 4 **Designer**
simplifies the label design and displays the label WYSIWYG
- 5 **Printer spooler**
to monitor all print jobs and the state of the printer
- 6 **Drivers**
for setting and the communication with devices

Printing in stand-alone operation

This operating mode is the printer's ability to select and print labels even when it is not connected to a host system.

The label has to be designed with a software such as cablabel S3 or by direct programming with a text editor on a PC. Label formats, texts, graphics as well as database contents are stored on a memory card, a USB memory stick or in the internal IFFS memory.

Only variable data are sent to the printer via a keyboard, a barcode scanner, scales or other host systems and/or recalled by the Database Connector from the host and printed.



For further information see
www.cab.de/en/cablabel



Printer control and administration

Printer drivers

To control the printer with a software other than cablabel S3, cab provides drivers in 32 / 64 bit for operating systems starting from Windows Vista, Mac OS 10.6 and Linux with CUPS 1.2.



Windows¹⁾ drivers

cab printer drivers are certified according to WHQL. They ensure optimum stability on the Windows operating system.



Mac OS X²⁾ drivers

cab provides CUPS-based printer drivers for Mac OS X applications.



Linux drivers³⁾

Linux drivers are CUPS-based.

Drivers are offered on the DVD delivered with the printer and for free download at www.cab.de/en/support

Printer programming



JScript

To control the printer, cab has developed the embedded programming language JScript. See manual for free download at www.cab.de/en/programming



abc Basic Compiler

In addition to JScript and as an integral part of the firmware, it allows advanced printer programming before data are sent to printout. For example, external printer languages can be replaced without interfering in the current print job. Also data from other systems such as a scale, a barcode scanner or PLC can be integrated.

Printer integration



Printer Vendor Program

As a partner in SAP's⁴⁾ Printer Vendor Program, cab has developed a replace method to enable easy control of a cab printer via SAPScript from SAP R/3. Only variable data are sent to the printer by the host. Pictures and fonts that had priorly been stored in the local memory (IFFS, memory card, etc.) are merged.

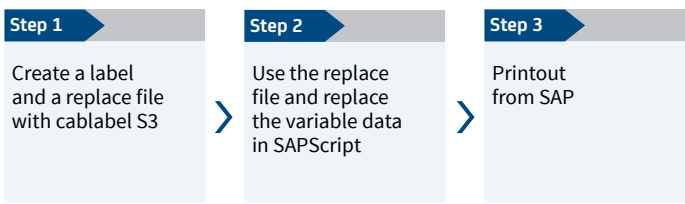

¹⁾ Windows is a registered trademark of Microsoft Corporation
²⁾ MAC OS X is a registered trademark of Apple Computer, Inc.
³⁾ Only for device series SQUIX (except of SQUIX MT), MACH 4S, EOS, Hermes+ and PX
⁴⁾ SAP and all corresponding logos are trademarks or registered trademarks of SAP SE

Printer administration



Configuration in Intranet and Internet

The HTTP and FTP server integrated in the printer via standard programs like a web browser or FTP clients allows printer control and configuration, firmware updates and memory card administration. Via email or SNMP, the SNMP and SMTP client datagram sends status, warning and error messages to administrators and users. Time and date are synchronized by a time server.



Network Manager in preparation

It is possible to simultaneously manage several printers within the network. Control, configuration, firmware updates, memory card administration, data synchronization and PIN administration are supported from one single location.

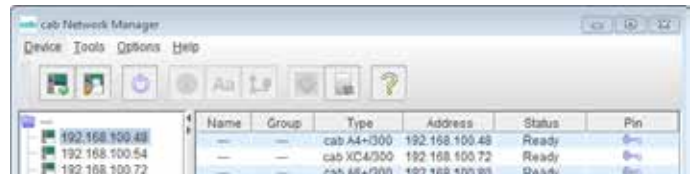

Database Connector

Printers connected to a network may directly access data from a central ODBC or OLEDB-ready database and print it on a label. While printing, data can be rewritten to the database.





Overview of accessories

● Typical ○ Possible ■ Standard □ Option

| Pos. | Printer add-ons | Basic device | Peel-off device | 1.1 | 1.2 | 1.3 | 1.4 | 1.5 |
|---------------------------------------|---|--------------|-----------------|---------|-------------------|-----------|-----------------------|-------------------------|
| | | | | SQUIX 2 | SQUIX 4.3 SQUIX 4 | SQUIX 6.3 | SQUIX 4.3 M SQUIX 4 M | SQUIX 4.3 MT SQUIX 4 MT |
| Extra equipment | | | | | | | | |
| 2.2 | Print rollers DR4-M25, -M50, -M80 | ● | ● | - | - | - | □ | □ |
| | Print roller DRS | ● | ● | □ | □ | □ | □ | □ |
| 2.3 | Antistatic brush | ● | ● | □ | □ | □ | □ | ■ |
| 2.6 | Adapter 100 | ● | ● | □ | □ | □ | □ | □ |
| 2.7 | SD memory card 8 GB | ● | ● | □ | □ | □ | □ | □ |
| 2.8 | USB memory stick 8 GB | ● | ● | □ | □ | □ | □ | □ |
| 2.9 | USB WLAN stick 2.4 GHz 802.11b/g/n + 5 GHz a/n/ac | ● | ● | □ | □ | □ | □ | □ |
| 2.10 | USB Bluetooth adapter | ● | ● | □ | □ | □ | □ | □ |
| 2.11 | Barcode tester for linear and 2D barcodes | ● | ● | □ | □ | □ | □ | - |
| Label dispensing | | | | | | | | |
| 2.12 | Present sensor PS800 | - | ● | □ | □ | □ | - | - |
| 2.13 | Present sensor PS900 | - | ● | □ | □ | □ | □ | - |
| 2.14 | Present sensor PS1000 | - | ● | - | - | - | □ | - |
| 2.15 | Extended peel-off plate DP410 | - | ● | □ | □ | □ | □ | - |
| 2.16 | Product sensor with reflector | - | ● | □ | □ | □ | □ | - |
| Interfaces | | | | | | | | |
| 3.1 | I/O interface | ● | ● | □ | □ | □ | □ | □ |
| 3.2 | I/O interface connector, SUB-D 25 pin | ● | ● | □ | □ | □ | □ | □ |
| 3.3 | Label selection - I/O box | ● | ● | □ | □ | □ | □ | □ |
| Connecting cable | | | | | | | | |
| 4.1 | Connecting cable RS232 C, 9/9 pin, length 3 m | ● | ● | □ | □ | □ | □ | □ |
| Cutting, perforating, stacking | | | | | | | | |
| 5.1 | Cutters CU200, CU400, CU600 with cutter tray | ● | ○ | □ | □ | □ | □ | □ |
| | | ● | ○ | - | □ | - | □ | - |
| 5.2 | Perforation cutters PCU400/2,5, PCU400/10 | ● | ○ | - | □ | - | □ | □ |
| 5.3 | Stacker with cutter and base frame ST400 M | ● | ○ | - | - | - | □ | □ |
| Label rewinding, unwinding | | | | | | | | |
| 6.1 | Rewind guide plates RG200, RG400 | - | ● | □ | □ | - | □ | - |
| 6.2 | External rewinders ER204, ER206 in preparation | ● | ○ | - | □ | □ | ○ | ○ |
| 6.3 | External rewinders ER1/210, ER2/210 ¹⁾ | ● | ○ | - | □ | □ | ○ | ○ |
| 6.5 | External rewinders ER4/300, ER6/300 | ● | ○ | - | □ | □ | ○ | ○ |
| 6.6 | External unwinders EU4/300, EU6/300 | ● | ○ | - | □ | □ | □ | □ |
| 6.7 | Adapter kit for rewinders and unwinders | ● | ○ | - | □ | □ | □ | □ |
| Applicators and demand modules | | | | | | | | |
| 7.1-7.5 | Applicators S1000-220, -300, -400 | - | ● | □ | □ | □ | □ | - |
| 7.6-7.8 | Applicator S3200 | - | ● | □ | □ | - | □ | - |
| 7.9 | Demand modules S5104, S5106 | - | ● | - | □ | □ | - | - |
| 7.10 | All-around labeler | - | ● | □ | □ | - | □ | - |
| Mounting equipment | | | | | | | | |
| 8.1 | Mounting plate | - | ● | □ | □ | - | - | - |
| 8.2 | Profiles 40, 80, 120 mm | - | ● | □ | □ | - | - | - |
| 8.3 | Base plate 500 x 255 mm | - | ● | □ | □ | - | - | - |
| 8.4 | Floor stand 1600 | - | ● | □ | □ | □ | - | - |
| 8.5 | Printer holder | - | ● | □ | □ | □ | - | - |
| Special covers and chassis | | | | | | | | |
| 9.1 | Hinged cover for ESD sectors | ● | ● | □ | □ | □ | □ | □ |
| 9.2 | Hinged cover for the food industry | ● | ● | □ | □ | □ | □ | □ |
| 9.3 | Stainless steel chassis for the food industry | ● | ● | - | □ | □ | □ | - |
| 9.4 | Dust protection chassis | ● | ● | - | □ | ○ | □ | - |

¹⁾ from the A+ printer series, adapted to SQUIX; provided until the external rewinders ER20x are available

Accessories

| Extra equipment | | Label dispensing | |
|-----------------|--|-------------------------|--|
| 2.2 |  <p>Print roller DR4-M25 Material width up to 25 mm Synthetic rubber coating for accurate imprint</p> | 2.12 |  <p>Present sensor PS800 for a left-aligned material guide</p> <p>The sensor detects the label in peel-off position. After the label has been removed the next one is automatically printed.</p> <p>Label width from 16 mm Label height from 6 mm Distance to locating edge 7 mm</p> |
| |  <p>Print roller DR4-M50 Material width up to 50 mm Synthetic rubber coating for accurate imprint</p> | 2.13 |  <p>Present sensor PS900 for a left-aligned or centered material guide</p> <p>The moveable sensor is foremost used with very small labels or labels that are shaped according to user specifications. After the label has been removed the next one is automatically printed.</p> <p>Label width from 4 mm Label height from 6 mm Left-aligned: distance to locating edge 12-60 mm centered: position middle centered</p> |
| |  <p>Print roller DR4-M80 Material width up to 80 mm Synthetic rubber coating for accurate imprint</p> | 2.14 |  <p>Present sensor PS1000 for a centered material guide</p> <p>The sensor detects the label in peel-off position. After the label has been removed the next one is automatically printed.</p> <p>Label width from 4 mm Label height from 6 mm Position middle centered</p> |
| |  <p>Print roller DRS4 Material width up to 120 mm Silicone coating for an extra long service life at a higher imprint tolerance</p> | 2.15 |  <p>Extended peel-off plate DP410 for strong-adhesive labels or labels with a thick carrier material that are hard to remove. Only in conjunction with printing on demand triggered via a display button or control signal. A present sensor cannot be used.</p> |
| 2.3 |  <p>Antistatic brush Particularly with plastic materials the electrostatic charge is discharged after printing.</p> | 2.16 |  <p>Product sensor with reflector Reflective light barrier to automatically detect a product on the conveyor belt</p> |
| 2.6 |  <p>Adapter 100 for label rolls with 100 mm core diameter and more than 180 mm outside diameter</p> | Interfaces | |
| 2.7 |  <p>SD memory card 8 GB</p> | 3.1 |  <p>I/O interface Labeling is started with a PLC, a sensor or a hand switch. At the same time, status and error messages are issued. Standard with peel-off devices, accessory to basic devices</p> |
| 2.8 |  <p>USB memory stick 8 GB</p> | 3.2 |  <p>I/O interface connector, SUB-D 25 pin with screw clamps to connect all control signals to the I/O interface</p> |
| 2.9 |  <p>USB WLAN stick 2.4 GHz 802.11b/g/n + 5 GHz 802.11a/n/ac in infrastructure mode with rod antenna for extended reach</p> | 3.3 |  <p>Label selection - I/O box Up to 16 different labels per box can be selected from the memory card by a master control, e.g. PLC. Two boxes can be connected. The I/O box allows simple PLC control processes with four inputs and outputs each via abc programming.</p> |
| 2.10 |  <p>USB Bluetooth adapter</p> | Connecting cable | |
| 2.11 |  <p>Barcode tester for linear and 2D barcodes The readability or content of a horizontally or vertically printed barcode is checked by a camera right after the printing. In case of a faulty code printing is stopped and the label removed.</p> <p>The tester can be used in tear-off mode, peel-off mode or with an external rewinder. For further information see the operator's manual.</p> | 4.1 |  <p>Connecting cable RS232 C 9/9 pin, length 3 m</p> |

Accessories

5.1



Cutting, perforating, stacking

Cutter CU

Paper labels, self-adhesive labels, cardboard, textile or plastic materials as well as shrink tubes can be cut.

Cutter tray

to collect up to approx. 50 labels

| Technical data | | | Cutter | | | |
|----------------------------|------------------|-------------------|--|----------------------|--|-----------|
| | | | CU200 | CU400 | | CU600 |
| To be used with | | | SQUIX 2 | SQUIX 4.3 SQUIX 4 | SQUIX 4.3 M SQUIX 4 M SQUIX 4.3 MT SQUIX 4 MT | SQUIX 6.3 |
| Material | Width | up to mm | 67 | 120 | 114 | 180 |
| | Weight cardboard | gr/m ² | 60-300 | | | |
| | Thickness | mm | 0.05-1.1 | | | |
| Cutting length | | from mm | 5 | | | |
| Gap height | | up to mm | 2.5 | | | |
| Cuts/min, without material | | up to | 100 | | | |
| Stop print job when | | | final cutter position has not been reached | | | |
| Cutter tray | | | | | | |
| Label height | | up to mm | - | 100 | - | - |

5.2



Perforation cutter PCU400

Continuous materials such as textiles or shrink tubes are perforated before they are manually separated. In addition, the materials can also be cut.

| Technical data | | | Perforation cutter | |
|----------------------------|------------------|-------------------|---|-----------|
| | | | PCU400/2,5 | PCU400/10 |
| To be used with | | | SQUIX 4.3, SQUIX 4, SQUIX 4.3 M, SQUIX 4 M, SQUIX 4.3 MT, SQUIX 4 MT | |
| Perforating | Web distance | mm | 2.5 | 10 |
| | Web width | mm | 0.5 | |
| Material | Width | up to mm | 85 | |
| | Weight cardboard | gr/m ² | 60-300 | |
| | Thickness | mm | 0.05-1.1 | |
| Cutting length | | from mm | 5 | |
| Gap height | | up to mm | 2.5 | |
| Cuts/min, without material | | up to | 100 | |
| Stop print job when | | | final cutter position has not been reached | |

5.3



Stacker with cutter ST400 M

- 1 The printed materials are cut and stacked. If the maximum stack height is reached, printing is interrupted. Limitations may apply to stiff or curved materials. We recommend to have these materials tested at our premise.
- 2 With the base frame the devices can be placed anywhere on the table.

| Technical data | | | Stacker with cutter | |
|----------------------------|------------------|-------------------|---|--|
| | | | ST400 M | |
| To be used with | | | SQUIX 4.3 M, SQUIX 4 M SQUIX 4.3 MT, SQUIX 4 MT | |
| Material | Width | mm | 20-100 | |
| | Weight cardboard | gr/m ² | 60-300 | |
| | Thickness | mm | 0.05-0.8 | |
| Cutting length | | mm | 20-150 | |
| Gap height | | up to mm | 1.2 | |
| Cuts/min, without material | | up to | 100 | |
| Stop print job when | | | Final cutter position has not been reached, paper jam, stacker cover open, stack height has been reached | |
| Stack height | | up to mm | 100 | |



Support table - label W x H

The support table and the protective cover are adapted to the label size. They have to be ordered separately.

Accessories

6.1



Label rewinding

with or without a cardboard core

Rewind guide plates RG for internal rewinding
Internal rewinding is possible with peel-off printers.
The peel-off plate is replaced by a rewind guide plate.

| Technical data | | Rewind guide plate | | |
|----------------|-----------------------------------|--------------------|--------------------------|----------------------------|
| | | RG200 | RG400 | |
| | To be used with | SQUIX 2 P | SQUIX 4.3 P SQUIX 4 P | SQUIX 4.3 MP SQUIX 4 MP |
| | Material width | up to mm | 67 | 120 |
| | Roll diameter | up to mm | 142 | |
| | Tightening axle for core diameter | mm | 38.1-40 | |
| | Winding | | outside | |
| | | | | |

6.2



External rewinders ER20x in preparation
Until the start of delivery the external rewinders ER1/210, ER2/210 from the A+ printer series are provided.

The rewriter is screwed with the label printer. Label winding is either outside or inside. The electronic swing arm control ensures that the winding stays consistent and tight.

| Technical data | | External rewriter | | |
|----------------|-----------------------------------|----------------------|--|-----------|
| | | ER204 | ER206 | |
| | To be used with | SQUIX 4.3 SQUIX 4 | SQUIX 4.3 M SQUIX 4 M SQUIX 4.3 MT SQUIX 4 MT | SQUIX 6.3 |
| | Material width | up to mm | 120 | 114 |
| | Roll diameter | up to mm | 205 | |
| | Tightening axle for core diameter | mm | 76 | |
| | Winding | | outside or inside | |
| | | | | |

6.5



External rewinders ER4, ER6 with built-in power supply
The rewriter may be attached to any external printer. Label winding is either outside or inside. The electronic swing arm control ensures that the winding stays consistent and tight.

| Technical data | | External rewriter | | |
|----------------|-----------------------------------|--|-------------------|--|
| | | ER4/300 | ER6/300 | |
| | To be used with | SQUIX 4.3, SQUIX 4 SQUIX 4.3 M, SQUIX 4 M SQUIX 4.3 MT, SQUIX 4 MT | SQUIX 6.3 | |
| | Material width | up to mm | 120 | |
| | Roll diameter | up to mm | 300 | |
| | Tightening axle for core diameter | mm | 76 | |
| | Winding | | outside or inside | |
| | | | | |

Adapter kit for
ER4, ER6 with SQUIX
ER4, ER6 and EU4, EU6 with SQUIX

6.6



Label unwinding

External unwinders EU
ensure consistent label feed with heavy rolls.
Either outside or inside wound rolls can be processed.

| Technical data | | External unwinder | | |
|----------------|-----------------|----------------------|--|-----------|
| | | EU4/300 | EU6/300 | |
| | To be used with | SQUIX 4.3 SQUIX 4 | SQUIX 4.3 M SQUIX 4 M SQUIX 4.3 MT SQUIX 4 MT | SQUIX 6.3 |
| | Material width | up to mm | 120 | 114 |
| | Roll diameter | up to mm | 390 | |
| | Core diameter | mm | 38.1 | |
| | | with adapter mm | 76 | |
| | Winding | | outside or inside | |

Adapter kit for
EU4, EU6 with SQUIX
ER4, ER6 and EU4, EU6 with SQUIX

Applicator S1000

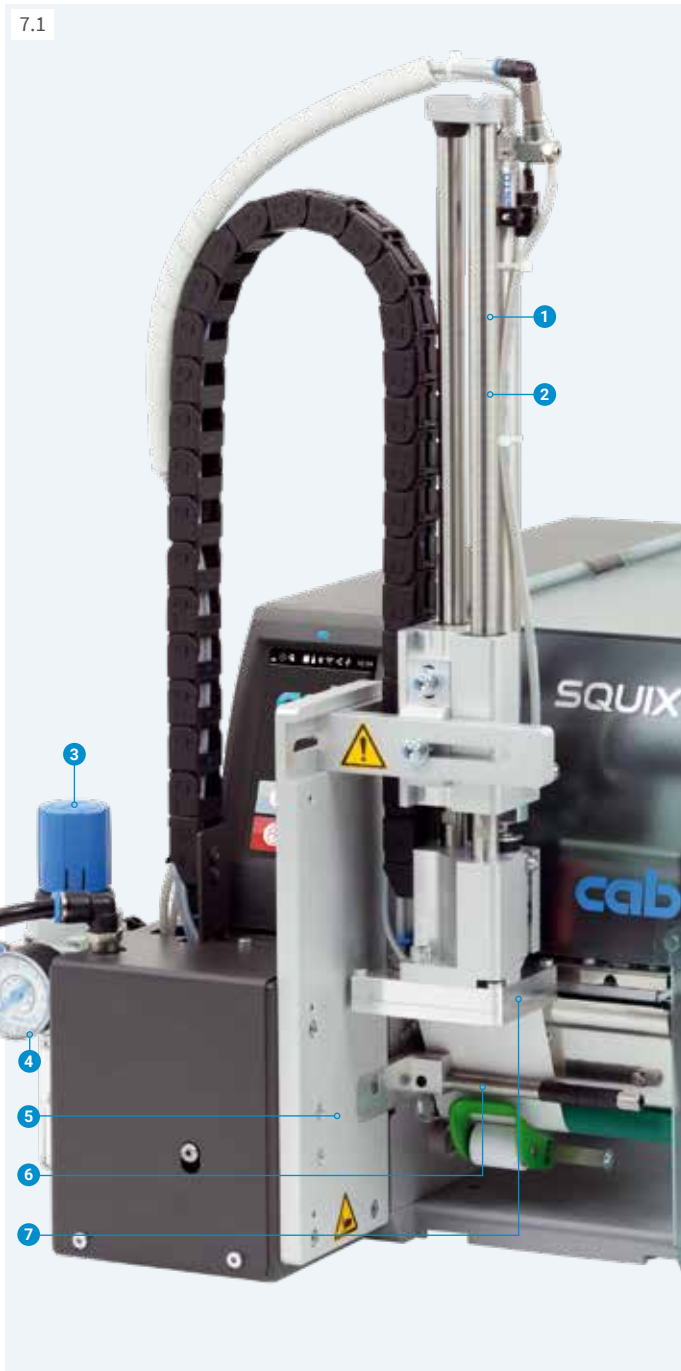

Labeling in real time

The applicator S1000 fixed to a SQUIX provides a cost-effective solution for peel-off printers - in semi-automatic operation or when vertically assembled in production lines. A stroke cylinder applies the label on the product.

- 1 **Long service life**
Low wear because of a ball-bearing linear guidance
- 2 **Variable product heights**
The stroke cylinder enables labeling at different heights. It is available in various stroke lengths.
- 3 **Compressed air pressure regulation unit**
Micro filters prevent from contamination. The regulation unit enables a permanent high labeling quality.
- 4 **High process reliability**
Supporting air, suction air and the stroke speed are all adjustable. If sensitive products and packagings are processed, the suction force can be reduced to less than 10N (1 kg). The vacuum holes are purged after every labeling process to avoid contamination.
- 5 **Label sizes**
Label widths 25 to 176 mm and heights 25 to 200 mm can be applied.
- 6 **Supporting air to blow the labels onto the pad**
- 7 **Pad**
The labels are given to the pad and held there by vacuum. Pad and label are moved by a stroke cylinder to the product.

Pre-dispense button

to check the labeling process. Pushing the button once means that the label is printed and taken over by the applicator. Pushing the button again starts the labeling process.

| Technical data | Applicator | | | |
|----------------------------------|--|---------------|-----------|-----|
| | S1000-220 | S1000-300 | S1000-400 | |
| To be used with | SQUIX 2, SQUIX 4.3, SQUIX 4 SQUIX 4.3 M, SQUIX 4 M, SQUIX 6.3 | | | |
| Cylinder stroke | mm | 220 | 300 | 400 |
| Tamp stroke below device | mm | 64 | 144 | 244 |
| Compressed air | bar | 4.5 | | |
| Cycle time approx. ¹⁾ | | 25 labels/min | | |

¹⁾ Calculated with 100 mm stroke below device, label height 100 mm, print speed 100 mm/s

Accessories

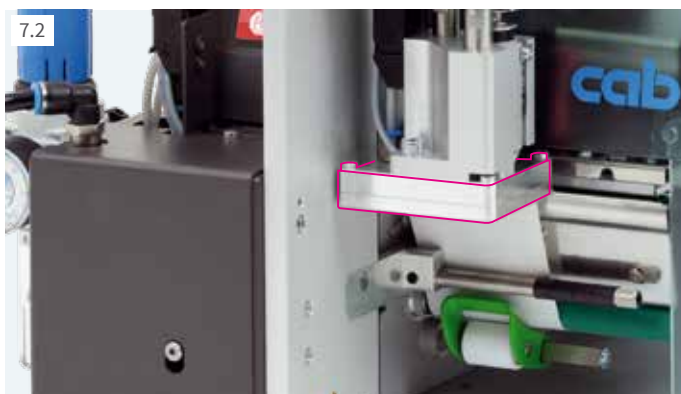

Universal pads

The rasterized vacuum holes are covered by a foil and pierced according to the label size.

| Technical data | Universal pad | | | |
|-------------------------|------------------------|----------------------|----------------------|-------|
| | A1021 | A1021 | | |
| Material guide | left-aligned, centered | | | |
| To be used with | SQUIX 2 | SQUIX 4.3 SQUIX 4 | SQUIX 4.3 SQUIX 4 | |
| Label width | mm | 25-63 | 25-70 | 25-90 |
| Label height | mm | 25-60 | | 25-90 |
| Product surface | | flat | | |
| Product height | | variable | | |
| Product during labeling | | not in motion | | |

Accessories Applicator S1000

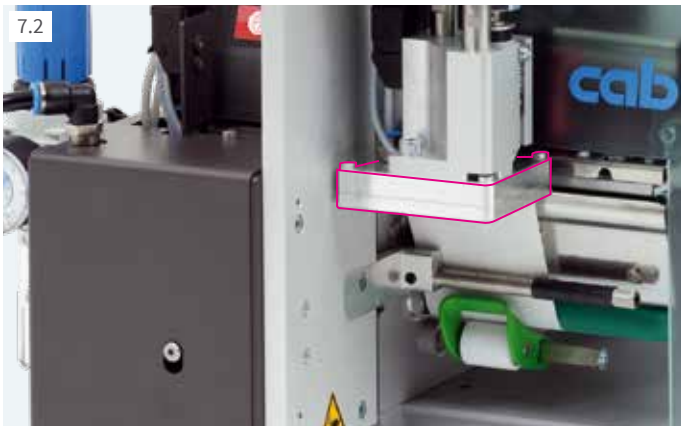

Tamp pads

are manufactured according to the label size.

| | | Tamp pad | | | |
|-------------------------|----|---------------|----------------------|-----------|--------------------------|
| Technical data | | A1021 | | | M1021 |
| Material guide | | left-aligned | | | centered |
| To be used with | | SQUIX 2 | SQUIX 4.3 SQUIX 4 | SQUIX 6.3 | SQUIX 4.3 M SQUIX 4 M |
| Label width | mm | 25-63 | 25-116 | 50-176 | 25-110 |
| Label height | mm | 25-200 | | | |
| Product surface | | flat | | | |
| Product height | | variable | | | |
| Product during labeling | | not in motion | | | |

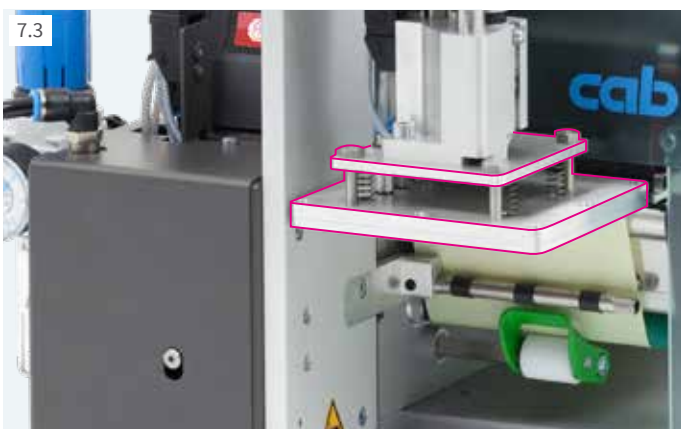

Universal pads spring-mounted

The spring deflection allows labeling even on curved surfaces. The rasterized vacuum holes are covered by a foil and pierced according to the label size.

Tamp pads spring-mounted

The spring deflection allows labeling even on curved surfaces; manufactured according to the label size

| | | Universal pad | | Tamp pad | |
|-------------------------|----|------------------------|--------------|---------------------------|------------------|
| Technical data | | A1321 | A1321 | A1321 | M1321 |
| Material guide | | left-aligned, centered | | left-aligned | |
| To be used with | | SQUIX 4.3, 4 | SQUIX 4.3, 4 | SQUIX 4.3, 4 SQUIX 6.3 | SQUIX 4.3 M, 4 M |
| Label width | mm | 25-116 | 25-116 | 25-116 | 50-176 |
| Label height | mm | 25-102 | 25-152 | 25-200 | |
| Product surface | | flat | | | |
| Product height | | variable | | | |
| Product during labeling | | not in motion | | | |

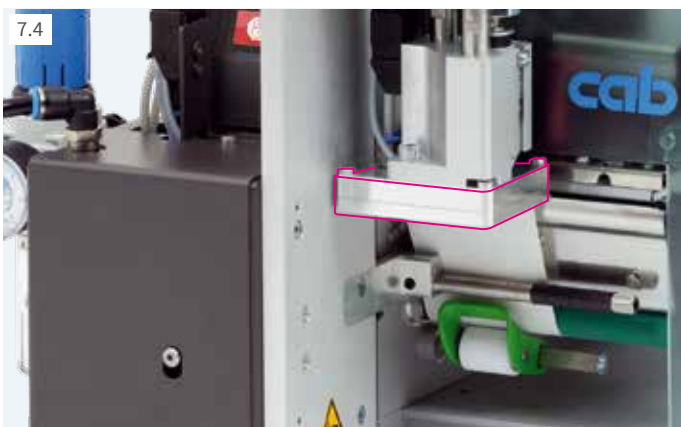

Blow pads

Labels may be blown on pressure-sensitive products. For this, the blow pad moves to a fixed height. The position of the product that has to be labeled is approx. 10 mm below.

| | | Blow pad | | | |
|-------------------------|----|----------------------------|--------------|-----------|------------------|
| Technical data | | A2021 | | | M2021 |
| Materialführung | | left-aligned | | | centered |
| To be used with | | SQUIX 2 | SQUIX 4.3, 4 | SQUIX 6.3 | SQUIX 4.3 M, 4 M |
| Label width | mm | 25-63 | 25-116 | 50-176 | 25-110 |
| Label height | mm | 25-100 | | | |
| Product surface | | flat | | | |
| Product height | | fixed | | | |
| Product during labeling | | in motion or not in motion | | | |

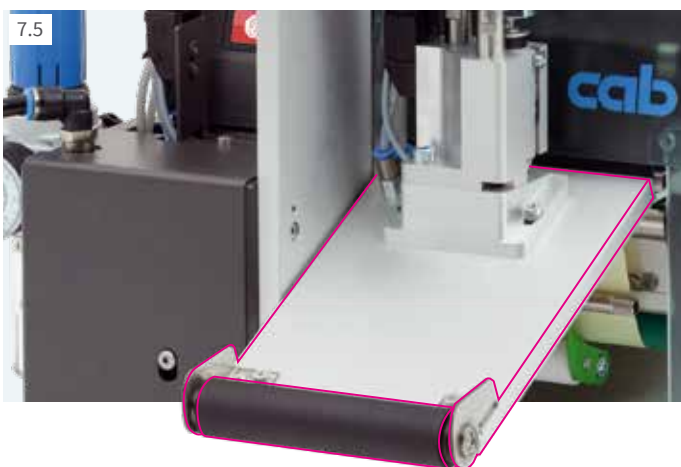

Roll-on pads

The label is moved right below the roll during the printing. The pad moves onto the product. The label is taken over by the product and rolled on.

| | | Roll-on pad | | |
|-------------------------|----|--------------|-----------|------------------|
| Technical data | | A1411 | | M1411 |
| Material guide | | left-aligned | | centered |
| To be used with | | SQUIX 4.3, 4 | SQUIX 6.3 | SQUIX 4.3 M, 4 M |
| Label width | mm | 25-116 | 50-176 | 25-110 |
| Label height | mm | 80-200 | | |
| Product surface | | flat | | |
| Product height | | variable | | |
| Product during labeling | | in motion | | |

Applicator S3200



Labeling in real time

An applicator S3200 fixed to a SQUIX provides a cost-effective solution for peel-off printers - in semi-automatic operation or when vertically assembled in production lines. With the S3200 printed labels are automatically applied on the product. The labels are placed with a rotary cylinder 45° to 95° to the horizontal and applied on the product with a short stroke cylinder. All information on the service life, predisense, compressed air regulation, process reliability and supporting air correspond with the applicator S1000 (see page 18).

| | | Applicator |
|----------------------------------|----------|---|
| | | S3200 |
| Technical data | | S3200 |
| To be used with | | SQUIX 2, SQUIX 4.3, SQUIX 4, SQUIX 4.3 M, SQUIX 4 M |
| Rotary cylinder | | 45°-95° |
| Stroke cylinder | up to mm | 30 |
| Compressed air | bar | 4.5 |
| Cycle time approx. ¹⁾ | | 20 labels/min |

¹⁾ Calculated with label height 40 mm, print speed 100 mm/s

Tamp or blow pads

are manufactured according to the label size.

| | | Tamp pad | | Blow pad | |
|-------------------------|----|---------------|--------------|----------------------------|------------|
| | | A3200-1100 | M3200-1100 | A3200-2100 | M3200-2100 |
| Technical data | | A3200-1100 | M3200-1100 | A3200-2100 | M3200-2100 |
| Material guide | | left-aligned | centered | left-aligned | centered |
| To be used with | | SQUIX 2 | SQUIX 4.3, 4 | SQUIX 4.3 M, 4 M | SQUIX 2 |
| Label width | mm | 4-63 | 10-116 | 4-110 | 10-63 |
| Label height | mm | 6-80 | | 10-80 | |
| Product surface | | flat | | | |
| Product during labeling | | not in motion | | in motion or not in motion | |

Demand modules



Demand modules S5104, S5106

to label products in motion on a conveyor belt. A product sensor detects the labeling position. The peel-off process is started and at the same time the next label is printed. The transport speed has to be synchronized with the print speed. A reflective sensor monitors the positioning.

| | | Demand module | |
|--|----|--|-----------|
| | | S5104 | S5106 |
| Technical data | | S5104 | S5106 |
| To be used with | | SQUIX 4.3, SQUIX 4 | SQUIX 6.3 |
| Material guide | | left-aligned | |
| Label width | mm | 25-116 | 50-176 |
| Label height | mm | 25-200 | |
| Distance from print line to peel-off plate | mm | 336-518 | |
| Product surface | | flat | |
| Product height | | fixed | |
| Product during labeling | | in motion, speed synchronized with the printer | |
| Cycle time approx. ¹⁾ | | 60 labels/min | |

¹⁾ Calculated with label height 100 mm, print speed 100 mm/s

All-around labeler

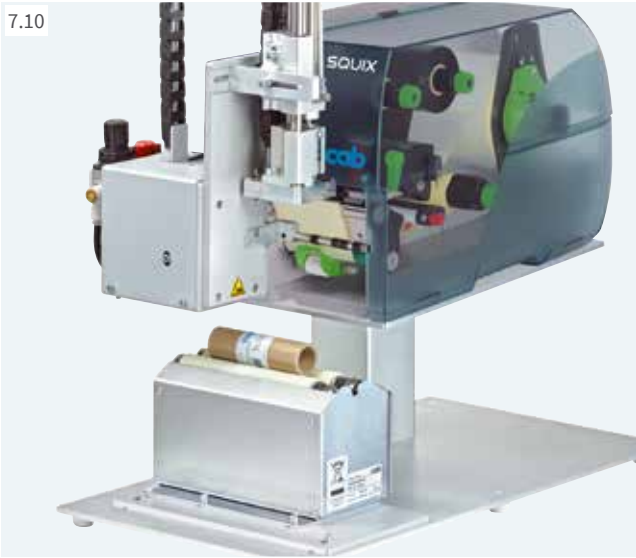

All-around labeler

With the module cylindrical objects can be labeled throughout the entire 360° circumference. The product is laid onto the rolls and the labeling process is started with a hand or foot switch.

| Technical data | Tamp pad | | |
|-------------------------|--------------|--|----------|
| | A1021 | M1021 | |
| Material guide | left-aligned | left-aligned | centered |
| To be used with | SQUIX 2 | SQUIX 4.3, SQUIX 4 SQUIX 4.3 M, SQUIX 4 M | |
| Label width | mm 25-63 | 25-116 | 25-110 |
| Label height | mm | 25-140 | |
| Product diameter | mm | 12-40 | |
| Product surface | | cylindric | |
| Product during labeling | | in rotary motion | |

Mounting equipment for the SQUIX label printers

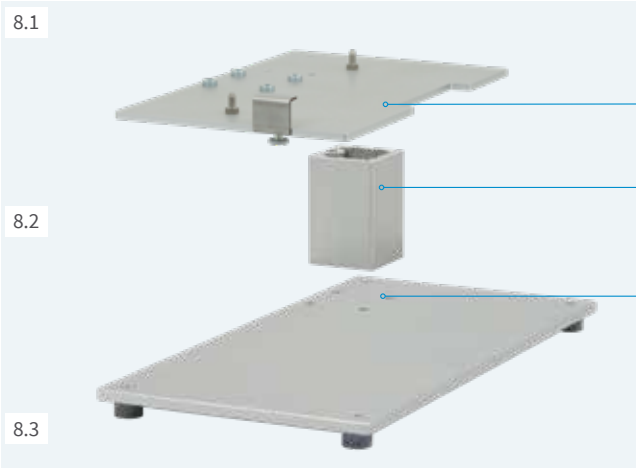

Mounting foot

to fix the print and apply system and the product holder

- 1 **Mounting plate**
The print and apply system is assembled on the mounting plate.
- 2 **Profile**
Aluminum square profile, standard lengths 40, 80, 120 mm; other lengths are possible on request
- 3 **Base plate**
to fix the product holder
Standard size 500 x 255 mm



Floor stand

It enables fast and flexible printer use in any production line. The labeling position is easily adjustable according to the height and width of the product. Four guide rollers provide mobility of the carriage. The floor stand is aligned with adjustable feet at the place of application.

| Technical data | Floor stand | |
|---------------------------------|-------------|-----------------|
| | 1600 | |
| Total height | mm | 1,600 |
| Labeling height | up to mm | 1,400 |
| Offset to label centre | mm | 230-500 |
| Carriage Width x Height x Depth | mm | 600 x 140 x 860 |



Printer holder

The label printer is fixed on the mounting plate and quick-locked.

Label printers with special covers or protection chassis

1.8



Printers with an electrically conductive hinged cover for ESD sectors

Available for all printer types

To protect from electrostatic charge, the cover is made of a conductive plastic. The material is very solid due to the carbon fibers and complies with the ESD standard.

If requested, also the entire casing can be designed conductive.

ESD-capable according to DIN EN 61340-5-1:2016

Surface resistance according to DIN IEC 60093 $\leq 10^4$ ohm;
charge is reduced from 1,000 V to 100 V in less than two seconds

9.1 Hinged cover as accessory

1.9



Printers with a detectable hinged cover for the food industry

Available for all printer types

The cover is magnetic so that splintered parts can be detected by metal detectors and x-ray inspection systems.

The blue surface serves to distinguish more effectively from food products.

If requested, also the entire casing can be designed detectable.

The material complies with the food regulations such as EU no. 10/2011 and FDA CFR 21 177.2600.

9.2 Hinged cover as accessory

9.3



Stainless steel chassis for the food industry

Available for SQUIX 4 and SQUIX 6 printers

Labels are removed through the front opening.

To replace the materials, the front flap is opened and the printer is pulled out on telescopic rails. The flap is closed for steam jet cleaning.

Protection class IP69K according to EN 60529

9.4



Dust protection chassis for dusty surroundings

Available for SQUIX 4 printers, SQUIX 6 on request

Labels are removed through the front opening.

The fan with the filter provides overpressure and prevents from dust entering the chassis.

Protection class IP52 according to EN 60529

Protection chassis with extraction socket for cleanrooms
on request

Maintenance



Label sensor

It can be unlocked with finger pressure and pulled out for cleaning.



Print head

Easy exchange in few simple steps. Adjustments or setups are basically not necessary.



Print roller

It can be easily unlocked with a screw for cleaning or replacement.

Assembly tool

ONE tool is provided with the printer to replace all components or to mount periphery.

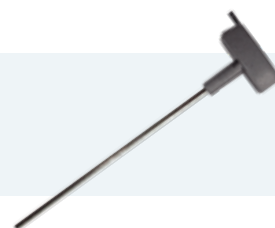

Services

Well-trained cab service engineers worldwide support in the maintenance and repair of the devices.

Send your printer to a cab service center or a cab service partner selected by us. Your device will be checked and repaired within few workdays. If requested, a loan device will be offered.

You prefer maintenance and repair on-site in your company? Then make an appointment with our Services Department: Phone **+49 721 6626 300**, Email: service.de@cab.de

Training

Enhance your know-how on cab devices with regard to an effective use, service and repair.

In Karlsruhe we offer trainings on the handling of the devices, label design, software, printer drivers, programming, database access as well as on how to integrate in networks or superior ERP systems. We gladly send you detailed information on all our current training offers on request.

Individually we offer trainings according to your specific demands - in Karlsruhe or on-site in your company.



Delivery program label printers

| Pos. | Part no. | Printers with a left-aligned material guide | Part no. | Print heads | dpi | Part no. | Wear parts |
|------|---|--|--------------------|----------------|-----|--|---|
| 1.1 |  | 5977030 Label printer SQUIX 2/300 | 5977384.001 | Print head 2 | 300 | 5954102.001 5954978.001 | Print roller DR2 Print roller DRS2 |
| | | 5977031 Label printer SQUIX 2/600 | 5977385.001 | Print head 2 | 600 | | |
| | | 5977032 Label printer SQUIX 2/300P | 5977384.001 | Print head 2 | 300 | 5954102.001 5954978.001 5954104.001 | Print roller DR2 Print roller DRS2 Rewind assist roller RR2 |
| | | 5977033 Label printer SQUIX 2/600P | 5977385.001 | Print head 2 | 600 | | |
| 1.2 |  | 5977014 Label printer SQUIX 4.3/200 | 5977382.001 | Print head 4.3 | 200 | 5954180.001 5954985.001 | Print roller DR4 Print roller DRS4 |
| | | 5977015 Label printer SQUIX 4.3/300 | 5977383.001 | Print head 4.3 | 300 | | |
| | | 5977001 Label printer SQUIX 4/300 | 5977444.001 | Print head 4 | 300 | | |
| | | 5977002 Label printer SQUIX 4/600 | 5977380.001 | Print head 4 | 600 | | |
| |  | 5977016 Label printer SQUIX 4.3/200P | 5977382.001 | Print head 4.3 | 200 | 5954180.001 5954985.001 5954183.001 | Print roller DR4 Print roller DRS4 Rewind assist roller RR4 |
| | | 5977017 Label printer SQUIX 4.3/300P | 5977383.001 | Print head 4.3 | 300 | | |
| | | 5977004 Label printer SQUIX 4/300P | 5977444.001 | Print head 4 | 300 | | |
| | | 5977005 Label printer SQUIX 4/600P | 5977380.001 | Print head 4 | 600 | | |
| 1.3 |  | 5977034 Label printer SQUIX 6.3/200 | 5977386.001 | Print head 6.3 | 200 | 5954245.001 5954979.001 | Print roller DR6 Print roller DRS6 |
| | | 5977035 Label printer SQUIX 6.3/300 | 5977387.001 | Print head 6.3 | 300 | | |
| | | 5977036 Label printer SQUIX 6.3/200P | 5977386.001 | Print head 6.3 | 200 | 5954245.001 5954979.001 5954246.001 | Print roller DR6 Print roller DRS6 Rewind assist roller RR6 |
| | | 5977037 Label printer SQUIX 6.3/300P | 5977387.001 | Print head 6.3 | 300 | | |
| Pos. | Part no. | Printers with a centered material guide | Part no. | Print heads | dpi | Part no. | Wear parts |
| 1.4 |  | 5977018 Label printer SQUIX 4.3/200M | 5977382.001 | Print head 4.3 | 200 | 5954180.001 5954985.001 5953700.001 5953701.001 5953702.001 | Print roller DR4 Print roller DRS4 Print roller DR4-M25 Print roller DR4-M50 Print roller DR4-M80 |
| | | 5977019 Label printer SQUIX 4.3/300M | 5977383.001 | Print head 4.3 | 300 | | |
| | | 5977010 Label printer SQUIX 4/300M | 5977444.001 | Print head 4 | 300 | | |
| | | 5977011 Label printer SQUIX 4/600M | 5977380.001 | Print head 4 | 600 | | |
| |  | 5977022 Label printer SQUIX 4.3/200MP | 5977382.001 | Print head 4.3 | 200 | 5954180.001 5954985.001 5953700.001 5953701.001 5953702.001 5954183.001 | Print roller DR4 Print roller DRS4 Print roller DR4-M25 Print roller DR4-M50 Print roller DR4-M80 Rewind assist roller RR4 |
| | | 5977023 Label printer SQUIX 4.3/300MP | 5977383.001 | Print head 4.3 | 300 | | |
| | | 5977007 Label printer SQUIX 4/300MP | 5977444.001 | Print head 4 | 300 | | |
| | | 5977008 Label printer SQUIX 4/600MP | 5977380.001 | Print head 4 | 600 | | |
| 1.5 |  | 5977024 Label printer SQUIX 4.3/300MT | 5977383.001 | Print head 4.3 | 300 | 5954180.001 5954985.001 5953700.001 5953701.001 5953702.001 | Print roller DR4 Print roller DRS4 Print roller DR4-M25 Print roller DR4-M50 Print roller DR4-M80 |
| | | 5977012 Label printer SQUIX 4/300MT | 5977444.001 | Print head 4 | 300 | | |
| | | 5977025 Label printer SQUIX 4/600MT | 5977380.001 | Print head 4 | 600 | | |

| Pos. | Part no. | Special printers |
|------|--------------------|--|
| 1.8 | 5977xxx.121 | Printers with a hinged cover for ESD sectors Label printer SQUIX x/xxx-ESD Label printer SQUIX x/xxxP-ESD "x" - choose device from Pos. 1.1-1.5 |
| 1.9 | 5977xxx.122 | Printers with a hinged cover for the food industry Label printer SQUIX x/xxx-FOOD Label printer SQUIX x/xxxP-FOOD "x" - choose device from Pos. 1.1-1.5 |

x - user specific part no. following request

| Scope of delivery: | | | | | | | | | | |
|--|----------------|-------------|-----------|----------------|-----------|-------------|-------------|----------------|------------|-------------|
| <p>Label printer Power cable Type E+F, length 1.8 m Connecting cable USB, length 1.8 m USB WLAN stick 2.4 GHz 802.11b/g/n Operator's manual DE/EN</p> | | | | | | | | | | |
| <p>DVD:</p> <p>Operator's manual in 30 languages Configuration manual DE/EN/FR Service manual DE/EN Spare parts list DE/EN Programming manual EN WHQL certified Windows printer drivers for <table border="0"> <tr> <td>Windows Vista</td> <td>Server 2008</td> </tr> <tr> <td>Windows 7</td> <td>Server 2008 R2</td> </tr> <tr> <td>Windows 8</td> <td>Server 2012</td> </tr> <tr> <td>Windows 8.1</td> <td>Server 2012 R2</td> </tr> <tr> <td>Windows 10</td> <td>Server 2016</td> </tr> </table> <p>Apple Mac OS X printer drivers DE/EN/FR Linux printer drivers DE/EN/FR Label software cablabel S3 Lite cablabel S3 Viewer Database Connector</p> </p> | Windows Vista | Server 2008 | Windows 7 | Server 2008 R2 | Windows 8 | Server 2012 | Windows 8.1 | Server 2012 R2 | Windows 10 | Server 2016 |
| Windows Vista | Server 2008 | | | | | | | | | |
| Windows 7 | Server 2008 R2 | | | | | | | | | |
| Windows 8 | Server 2012 | | | | | | | | | |
| Windows 8.1 | Server 2012 R2 | | | | | | | | | |
| Windows 10 | Server 2016 | | | | | | | | | |

Delivery program accessories



| Pos. | Part no. | Extra equipment |
|------|--|---|
| 2.3 | 5977797 5977339 | Antistatic brush 2" Antistatic brush 4" / 6" |
| 2.6 | 5959622 | Adapter 100 |
| 2.7 | 5977370 | SD memory card 8 GB |
| 2.8 | 5977730 | USB memory stick 8 GB |
| 2.9 | 5977731 | USB WLAN stick with rod antenna 2.4 GHz 802.11b/g/n + 5 GHz a/n/ac |
| 2.10 | 5977732 | USB Bluetooth adapter |
| 2.11 | 5978911.597 | Barcode tester for linear and 2D barcodes |
| Pos. | Part no. | Label dispensing |
| 2.12 | 5977585 | Present sensor PS800 |
| 2.13 | 5984482 5977538 | Present sensor PS 2/900 Present sensor PS 4/900 |
| 2.14 | 5977735 | Present sensor PS1000 |
| 2.15 | 5977798 5978908 5977799 | Extended peel-off plate DP210 Extended peel-off plate DP410 Extended peel-off plate DP610 |
| 2.16 | 5978909 | Product sensor with reflector |
| Pos. | Part no. | Interfaces |
| 3.1 | 5977767 | I/O interface |
| 3.2 | 5917651 | I/O interface connector SUB-D 25 pin |
| 3.3 | 5948205 | Label selection - I/O box |
| Pos. | Part no. | Connecting cable |
| 4.1 | 5550818 | Connecting cable RS232 C 9/9 pin, length 3 m |
| Pos. | Part no. | Cutting, perforating, stacking |
| 5.1 | 5979032 5978900 5979033 | Cutter CU200 Cutter CU400 Cutter CU600 |
| 5.2 | 5978901 5978920 | Perforation cutter PCU400/2,5 Perforation cutter PCU400/10 |
| 5.3 | 5978902 | Stacker with cutter and base frame ST400 M |
| | 5xxxxxx | Support table, label WxH |





x - user specific part no. following request





| Pos. | Part no. | Label rewinding, unwinding |
|------|--|---|
| 6.1 | 5979031 5978903 | Rewind guide plate RG200 Rewind guide plate RG400 |
| 6.2 | 5978904 5979074 | In preparation: External rewinder ER204 External rewinder ER206 |
| 6.3 | 5948102.597 5943251.597 | External rewinder ER1/210 External rewinder ER2/210 |
| 6.5 | 5946090 5946420 | External rewinder ER4/300 External rewinder ER6/300 |
| 6.6 | 5946091 5946421 | External unwinder EU4/300 External unwinder EU6/300 |
| 6.7 | 5978943 | Adapter kit for ER4, ER6 and EU4, EU6 |
| Pos. | Part no. | Applicators and demand modules |
| 7.1 | 5976086 5976087 5976088 | Applicator S1000-220 Applicator S1000-300 Applicator S1000-400 |
| 7.2 | 5949072 | Universal pad A1021 70x60 |
| | 5949075 | Universal pad A1021 90x90 |
| | 59xxxxx 5977xxx | Tamp pad A1021 WxH Tamp pad M1021 WxH |
| 7.3 | 5949076 | Universal pad A1321 116x102 |
| | 5949077 | Universal pad A1321 116x152 |
| | 59xxxxx 5977xxx | Tamp pad A1321 WxH Tamp pad M1321 WxH |
| 7.4 | 59xxxxx 5977xxx | Blow pad A2021 WxH Blow pad M2021 WxH |
| 7.5 | 59xxxxx 5977xxx | Roll-on pad A1411 WxH Roll-on pad M1411 WxH |

x - user specific part no. following request

Delivery program accessories

| Pos. | Part no. | Applicators and demand modules |
|------|--|--|
| 7.6 |  5976085 | Applicator S3200 |
| 7.7 |  59xxxxx 5977xxx | Tamp pad A3200-1100 WxH Tamp pad M3200-1100 WxH |
| 7.8 |  59xxxxx 5977xxx | Blow pad A3200-2100 WxH Blow pad M3200-2100 WxH |
| 7.9 |  5976083 5979035 | Demand module S5104 Demand module S5106 |
| 7.10 |  5976084 | All-around labeler |

| Pos. | Part no. | Mounting equipment |
|------|--|--|
| 8.1 |  5979036 5978910 5978923 | Mounting plate SQUIX 2 Mounting plate SQUIX 4 Mounting plate SQUIX 6 |
| 8.2 |  5958365 5965929 5971136 | Profile 40 Profile 80 Profile 120 |
| 8.3 |  5961203 | Base plate 500x255 |
| 8.4 |  5947400 | Floor stand 1600 |
| 8.5 |  5979037 5978922 5979038 | Printer holder SQUIX 2 Printer holder SQUIX 4 Printer holder SQUIX 6 |

| Pos. | Part no. | Special covers and protection chassis |
|------|--|--|
| 9.1 |  5977771.001 5977763.001 5977772.001 | Hinged cover for ESD sectors for SQUIX 2 for SQUIX 4 for SQUIX 6 |
| 9.2 |  5977773.001 5977764.001 5977774.001 | Hinged cover for the food industry for SQUIX 2 for SQUIX 4 for SQUIX 6 |
| 9.3 |  5979071 5979305 | Stainless steel chassis for the food industry for SQUIX 4 for SQUIX 6 |
| 9.4 |  5979080 on request on request | Dust protection chassis for SQUIX 4 for SQUIX 6 Protection chassis for cleanrooms |

x - user specific part no. following request

| Pos. | Part no. | Label software |
|-------|--|---|
| 11.7 |  5588000 | cablabel S3 Lite |
| | 5588001 5588100 5588101 5588150 5588151 5588152 | cablabel S3 Pro 1 WS cablabel S3 Pro 5 WS cablabel S3 Pro 10 WS cablabel S3 Pro 1 additional licence cablabel S3 Pro 4 additional licences cablabel S3 Pro 9 additional licences |
| 11.10 | 5588002 5588105 5588106 5588155 5588156 5588157 | cablabel S3 Print 1 WS cablabel S3 Print 5 WS cablabel S3 Print 10 WS cablabel S3 Print 1 additional licence cablabel S3 Print 4 additional licences cablabel S3 Print 9 additional licences |
| | in preparation | cablabel S3 Print Server |
| | 9009950 | Programming manual EN, printed copy |

cab product overview

Label printers MACH1, MACH2
in the lower price segment



Label printers MACH 4S
where little space is available



Label printers EOS1
Desktop device for label rolls up to diameter 152 mm



Label printers EOS4
Desktop device for label rolls up to diameter 203 mm



Label printers SQUIX 2
Industrial device for print widths up to 57 mm



Label printers SQUIX 4
Industrial device for print widths up to 108 mm



Label printers SQUIX 6
Industrial device for print widths up to 168 mm



Label printers A8+
Industrial device for print widths up to 216 mm



Label printers XD4T
for double-sided printing



Label printers XC
for two-color printing



Print and apply systems Hermes+
for automation



Print and apply systems Hermes C
for two-color printing and applying



Print modules PX
to be integrated in labeling machines



Labels
made from more than 400 materials



Ribbons
in wax, resin and resin/wax qualities



Label software cablabel S3
Design, print, control



Label dispensers HS, VS
for horizontal or vertical dispense



Labeling heads IXOR
to be integrated in labeling machines



Marking lasers FL+
with output powers 10 to 50 Watt



Laser marking systems XENO 1
for single workpieces and series



Germany
cab Produkttechnik GmbH & Co KG
Karlsruhe
Phone +49 721 6626 0
www.cab.de

France
cab Technologies S.à.r.l.
Niedermodern
Phone +33 388 722501
www.cab.de/fr

USA
cab Technology, Inc.
Chelmsford, MA
Phone +1 978 250 8321
www.cab.de/us

Mexico
cab Technology, Inc.
Juárez
Phone +52 656 682 4301
www.cab.de/es

Taiwan
cab Technology Co., Ltd.
Taipei
Phone +886 (02) 8227 3966
www.cab.de/tw

China
cab (Shanghai) Trading Co., Ltd.
Shanghai
Phone +86 (021) 6236 3161
www.cab.de/cn

China
cab (Shanghai) Trading Co., Ltd.
Guangzhou
Phone +86 (020) 2831 7358
www.cab.de/cn

South Africa
cab Technology (Pty) Ltd.
Randburg
Phone +27 11 886 3580
www.cab.de/za

cab // 820 distribution partners in more than 80 countries

cab
we identify more