



## Print and Apply System Hermes+

Made in Germany

*All information on scopes of delivery,  
design and technical specifications  
correspond to the date of the printing.  
Subject to change.*

*For current data refer to website  
[www.cab.de/en/hermesplus](http://www.cab.de/en/hermesplus).*

# Contents

<b>Label printer Hermes+</b> . . . . .	<b>4</b>
<b>Overview types.</b> . . . . .	<b>4 - 5</b>
<b>Technical details</b> . . . . .	<b>6</b>
<b>Interfaces</b> . . . . .	<b>7</b>
<b>Technical data</b> . . . . .	<b>8 - 9</b>
<b>Applicators</b> . . . . .	<b>10</b>
<b>Overview applicators and transfer modules</b> . . . . .	<b>11</b>
<b>Product marking.</b> . . . . .	<b>12</b>
<b>Swing applicator 3214</b> . . . . .	<b>12</b>
<b>Stroke applicator 4114 / 4116</b> . . . . .	<b>13 - 14</b>
<b>Stroke-turn applicator 4214</b> . . . . .	<b>15</b>
<b>Stroke applicator 4414</b> . . . . .	<b>16</b>
<b>Swing-stroke applicator 4514.</b> . . . . .	<b>17</b>
<b>Package marking</b> . . . . .	<b>19</b>
<b>Front-side applicator 3014 / 3016</b> . . . . .	<b>19</b>
<b>Stroke applicator 4014 / 4016</b> . . . . .	<b>20 - 21</b>
<b>Stroke-blow applicator 4614</b> . . . . .	<b>22</b>
<b>Demand module 5114</b> . . . . .	<b>23</b>
<b>Vacuum-belt applicator 5314 / 5316.</b> . . . . .	<b>24</b>
<b>Air-jet-box 6014</b> . . . . .	<b>25</b>
<b>Overview accessories</b> . . . . .	<b>26</b>
<b>Accessories.</b> . . . . .	<b>27</b>
<b>Accessories - Mounting aid</b> . . . . .	<b>28 - 29</b>
<b>Accessories - Floor stand</b> . . . . .	<b>30</b>
<b>Software</b> . . . . .	<b>31</b>
<b>Software functions of the label printer.</b> . . . . .	<b>31</b>
<b>Software-Tools - Label software and monitoring</b> . . . . .	<b>32</b>
<b>Printer driver</b> . . . . .	<b>33</b>
<b>Delivery program</b> . . . . .	<b>34 - 37</b>

# Overview types label printer Hermes+

Hermes+ is designed for automated print and apply processes in production lines. Different applicators allow the label to be applied via roll-on, blow-on or tamp-on to a product or packaging.



## The Sleek

For small labels with high printing accuracy.

1.1 Label printer	Hermes+ 2	
Print resolution dpi	300	600
Print width up to mm	54.2	57
Print speed up to mm/s	150	100
Label roll Ø mm	205 / 305	
Label width up to mm	58	



## The Universal

Our top-seller with high printing accuracy and an extensive range of accessories.

1.2 Label printer	Hermes+ 4		
Print resolution dpi	203	300	600
Print width up to mm	104	105.6	105.6
Print speed up to mm/s	300	250	100
Label roll Ø mm	205 / 305		
Label width up to mm	114		



## The Wide

Ideal for Odette, UCC and GS1 labels.

1.3 Label printer	Hermes+ 6	
Print resolution dpi	203	300
Print width up to mm	168	162.6
Print speed up to mm/s	200	200
Label roll Ø mm	205 / 305	
Label up to mm	174	

# Overview types label printer Hermes+



Label reel Ø 205 mm



Label roll Ø 205 mm



Label roll Ø 305 mm



Dispensing direction to the left



Dispensing direction to the right



Cover protecting the device from dirt

# Technical details

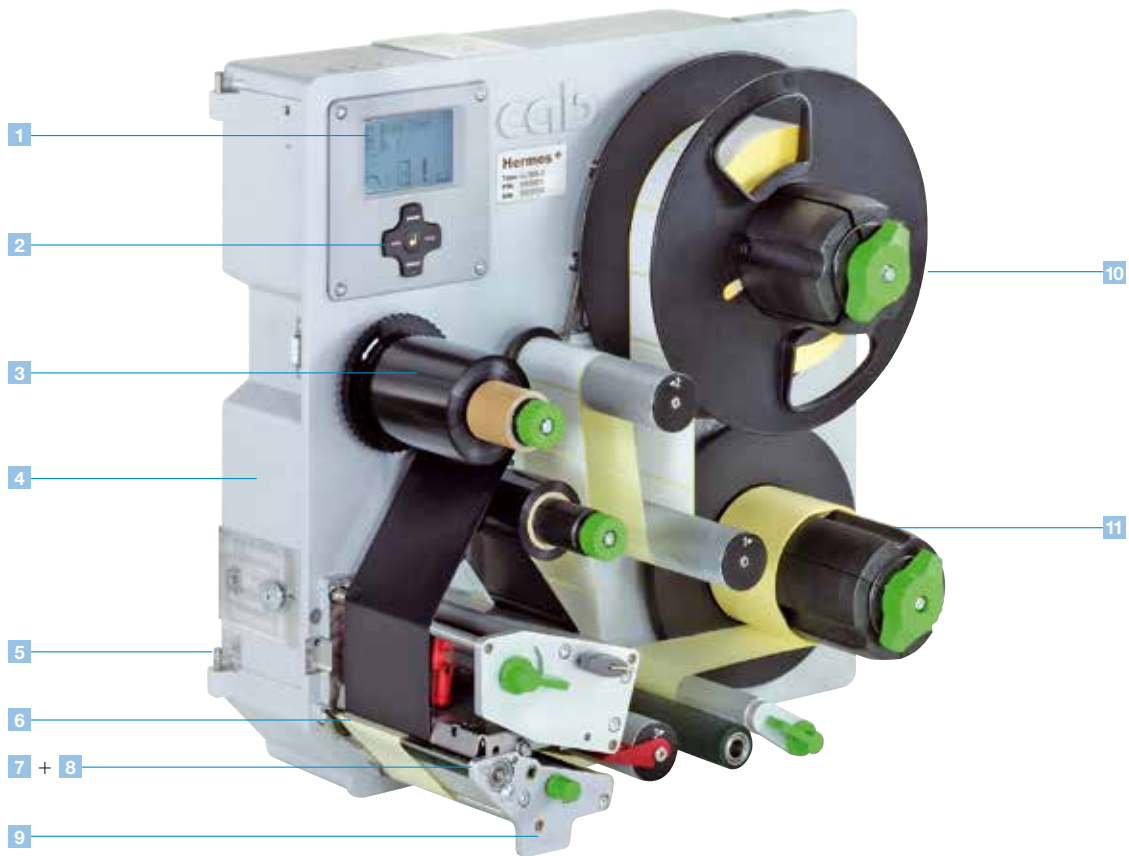

## 1 Large graphic display

White backlight for optimum readability. Depending on the installation position the display may be turned in steps of 90°.

## 2 Navigator pad

Simple, interactive menu control. The day and night design only displays applicable functions. Along with the graphic display menu navigation is made easy to understand.

## 3 Ribbon holder

Simple and centered insertion of the ribbon with the three-part tightening axles.

## 4 Solid metal chassis

Made of die-cast aluminum providing a basis for the assembly of all components.

## 5 Assembly applicator

The applicator is mounted on hinges and allows easy removal for maintenance.

## 6 Print positioning

After having exchanged the label roll the print position is automatically set after a few printed labels. The label position is kept, even if the machine is switched off.

## 7 Printhead

The printhead may be exchanged in just a few steps. And no need of doing adjustments and settings.

## 8 Ribbon saver

Is used for labels to be partially printed. The printhead is lifted within the unprinted area and the ribbon stopped during label feeding.

## 9 Transport system

The ball bearing mounted rollers for highly accurate print and precise label feeding.

## 10 Label unwinder

Swing lever and integrated brake make sure that the labels are unwound with constant tension.

## 11 Rewinder

The liner of a label roll is completely rewound after the labels have been peeled off. The three-part tightening axis enables an easy exchange of the roll.

## Print direction

All Hermes+ label printers with applicators are available with left and right print direction.

# All required interfaces

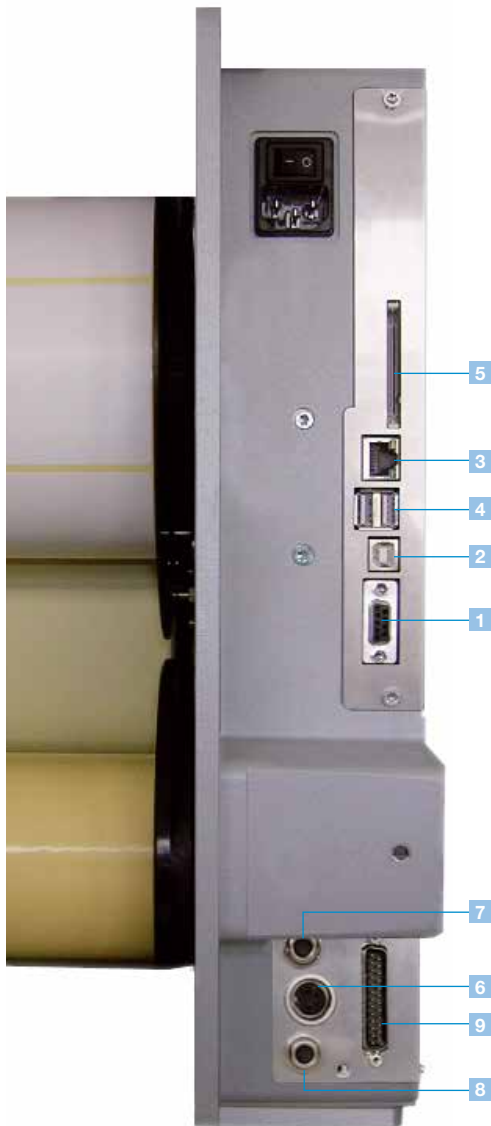

- 1 RS232C- interface
- 2 USB 2.0 Slave interface
- 3 Ethernet 10/100 Base T-interface with TCP/IP
- 4 Two USB-Master-interfaces for connection of an external operation panel, keyboard, scanner or service key
- 5 Slot for memory card CompactFlash Type I
- 6 Connection warning light  
Displays the printer status  
Green Device switched on  
Yellow Prewarning end of label, end of ribbon  
Red Error
- 7 Connection main valve for air pressure supply:  
For centrally switching the compressed air supply on/off
- 8 Connection external E-stop  
In connection with a main valve this interface allows to cut-off the compressed air supply in case of emergency
- 9 Digital I/O interface  
25-pin SUB-D connector  
All 24V in- and outputs are optically isolated

## Inputs

Start printing and applying  
Reprint  
Label feed  
Delete print job  
Pause  
Label dispensed  
Reset  
Stop printing and applying  
Print first label  
Label rotating 90°  
(Applicator 4214)

## Outputs

Ready to operate  
Print data available  
Paper feed on  
Prewarning end of ribbon  
Prewarning end of label  
Error end of ribbon  
Error end of label  
Label in dispensing position  
Basic position / upper end position  
Applying position / lower end position  
Common alarm

## Options



Interface Centronics bi-directional acc. to IEEE 1284.  
Interface RS422/RS485 1.200 up to 230.400 Baud/8 Bit.  
The interfaces are connected to the PC.  
Connection to the printer via USB connection cable.



Label selection box-I/O-box. Via PLC up to 16 different labels can be selected from the memory card. Control may also be to four in-/outputs via Basic Interpreter.

# Technical data

			1.1		1.2			1.3	
<b>Label printer</b>			<b>Hermes+ 2</b>		<b>Hermes+ 4</b>			<b>Hermes+ 6</b>	
<b>Print head</b>									
Print method			Thermal transfer/thermal direct						
Print resolution	dpi		300	600	203	300	600	203	300
Print speed up to	mm/s		150	100	300	250	100	200	200
Print width up to	mm		54.2	57	104	105.6	105.6	168	162.6
<b>Material</b>									
Labels on rolls or reel Hermes+ 2			Paper, plastics such as PET, PE, PP, PVC, PU, acrylate, PI						
Thickness mm/weight	g/m <sup>2</sup>		0,055–0,35/60–160						
Width labels <sup>1)</sup>	mm		4–58		10–114			50–174	
Width liner	roll	mm	24–62		24–118			54–178	
	reel	mm	10–62		—			—	
Label height <sup>1)</sup> when dispensing	mm		4–200		8–320			25–320	
Media roll:	Outside Ø	up to mm	205/305						
	Core Ø mm	roll / adapter	40/50		40/50			—	
		roll	76		76			76	
	Winding		outside or inside						
<b>Ribbon</b>									
Ink			outside or inside						
Roll diameter	up to mm		80		80			80	
Core diameter	mm		25		25			25	
Ribbon length variable	up to m		500		500			500	
Width <sup>2)</sup>	mm		60		114			165	
Ribbon saver			–		□			□	
<b>Internal rewriter</b>									
Total diameter	up to mm		155/210						
Core diameter	mm		76		76			76	
<b>Dimensions printer</b>									
Height mm	Label roll Ø 205 mm		400						
	Label roll Ø 305 mm		538						
Depth mm	Label roll Ø 205 mm		400						
	Label roll Ø 305 mm		518						
Width	mm		207		260			320	
Weight	kg		15		16			20	
<b>Label sensor</b>									
Gap sensor			for leading edge or punch marks and end of material						
Reflective sensor from the bottom or from the top			for print marks						
Distance to locating edge	mm		2–26		2–47			2–47	
<b>Electronics</b>									
Processor high speed 32 Bit Clock rate MHz			266						
RAM MB			64						
Memory IFFS MB Flash			8						
Slot for CompactFlash Type I memory card			■						
Battery buffer for real-time clock, printout of time and date, data storage on shut-down			■						
Warning signal: acoustic signal in case of error			■						
<b>Interfaces</b>									
Centronics bi-directional acc. to IEEE 1284			□						
RS232 C 1.200 up to 230.400 baud/8 bit			■						
USB 2.0 High Speed Slave for PC-connection			■						
Ethernet 10/100 Base T, LPD, RawIP-Printing, ftp-Printing, DHCP, HTTP, FTP, SMTP, SNMP, TIME, Zeroconf, mDNS, SOAP			■						
RS422, RS485 1.200 up to 230.400 Baud/8 bit			□						
2x USB Master for external operation panel, keyboard, scanner or service key			■						
Connection warning light			■						
Digital I/O-interface			■						
Connection cab applicator			■						
Connection external emergency stop			■						
Main valve for air-pressure supply			■						
<b>Operating data</b>									
Power supply			100–240 VAC ~ 50/60 Hz, PFC						
Power consumption			max. 300 W						
Temperature / Humidity:	Operation:		+ 5 - 40°C / 10 - 85% not condensing						
	Storage:		+ 0 - 60°C / 20 - 80% not condensing						
	Transport:		– 25 - 60°C / 20 - 80% not condensing						
Approvals			CE, FCC class A, CB, CCC, UL						

<sup>1)</sup> The label size is in addition defined through the type of the applicator.

Limitations may apply to small labels, thin materials or strong adhesives. Critical applications need to be tested and approved.

<sup>2)</sup> The ribbon should roughly be the same width as the label in order to avoid folding.



# Technical data

■ Standard □ Option

Operation panel	
Buttons / LED-display	Pause, Feed, Cancel, Menue, Enter, 4 x Cursor
LCD-graphic display	Width 60, Height 40 mm, text 4 lines, about 20 characters per line
Settings	
	Time, date, digital or analog clock 25 language settings system settings, print parameters, interfaces, security
On the Display	
	Data reception                      Clock WLAN field intensity              Date sheet Ethernet state                      abc debug Use memory                         Input buffer Temperature printhead          Remaining quantity of ribbon Access to memory card
Monitoring	
Stop printing if:	End of ribbon End of labels Printhead open
Warning if:	End of ribbon End of labels
Test routines	
System diagnosis	When switched on, including printhead testing
Short status. Status print	font list, device list, WLAN status, label profile, test grid, monitor mode, PPP status
Status reports	Status printout with information about settings, e.g. print length counter, runtime counter, etc. Request of status via software command. Status messages on the display, e.g. network error - no link, barcode error, etc.
Fonts	
Font types	5 Bitmap fonts incl. OCR-A, OCR-B and 3 Vector fonts Swiss 721, Swiss 721 Bold and Monospace 821 internally available, loadable TrueType fonts. Thai and Chinese (simplified Chinese) available as option.
Character sets	Windows 1250 up to 1257, DOS 437, 737, 775, 850, 852, 857, 862, 864, 866, 869, EBC DIC 500, ISO 8859-1 up to -10 and -13 up to -16, WinOEM 720, UTF-8, Macintosh Roman, DEC MCS, KOI8-R. All West and East European Latin, Cyrillic, Greek, Hebrew and Arabic characters are supported. Thai and Chinese available as option.
Bitmap fonts	Size of width and height 1-3 mm Zoom 2-10 Orientation 0°, 90°, 180°, 270°
TrueType fonts	Size of width and height 0.9 - 128 mm Variable zoom, Orientation 360° in steps of 1°
Font formats	Bold, italic, underlined, outline, inverse, depending on character fonts
Font width	Variable

Graphics		
Graphic elements	Line, arrow, box, circle, ellipse, filled and filled with fading	
Graphic formats	PCX, IMG, BMP, TIF, MAC, GIF, PNG	
Barcodes		
Linear barcodes	Code 39, Code 93 Code 39 Full ASCII Code 128 A, B, C EAN 8, 13 EAN / UCC 128 EAN / UPC Appendix 2 EAN / UPC Appendix 5 FIM HIBC	Interleaved 2 / 5 Ident- and lead code of Deutsche Post AG Codabar JAN 8, 13 MSI Plessey Postnet RSS 14 UPC A, E, E0
2D-Codes	Aztec, Codablock F, Data Matrix, PDF 417, Micro PDF 417, UPS Maxicode, QR-Code, RSS 14 truncated, limited, stacked und stacked omnidirectional, EAN-Datamatrix, GS1 Data Bar	
	All codes are variable in height, module width and ratio. Orientation 0°, 90°, 180°, 270°. Optionally with check digit, printed characters and start/stop code, depending on type of code.	
Software		
Programming	J-Script direct programming abc-Basic Compiler Database Connector	■ ■ ■
System diagnosis/ administration	Printer monitoring Network Manager	■ ■
Label software	cablabel® S3 Light cablabel® S3 Viewer cablabel® S3 Pro cablabel® S3 Print	■ ■ □ □
Windows driver certified	32/64 bit for Windows Vista                      Server 2003 Windows 7                            Server 2008 Windows 8                            Server 2008 R2 Windows 8.1                         Server 2012 Windows 10                         Server 2012 R2	■
Mac driver	OS X printer driver from version 10.6	■
Linux driver	32/64 Bit from CUPS 1.2	■
Stand-alone- operation		■

# Applicators

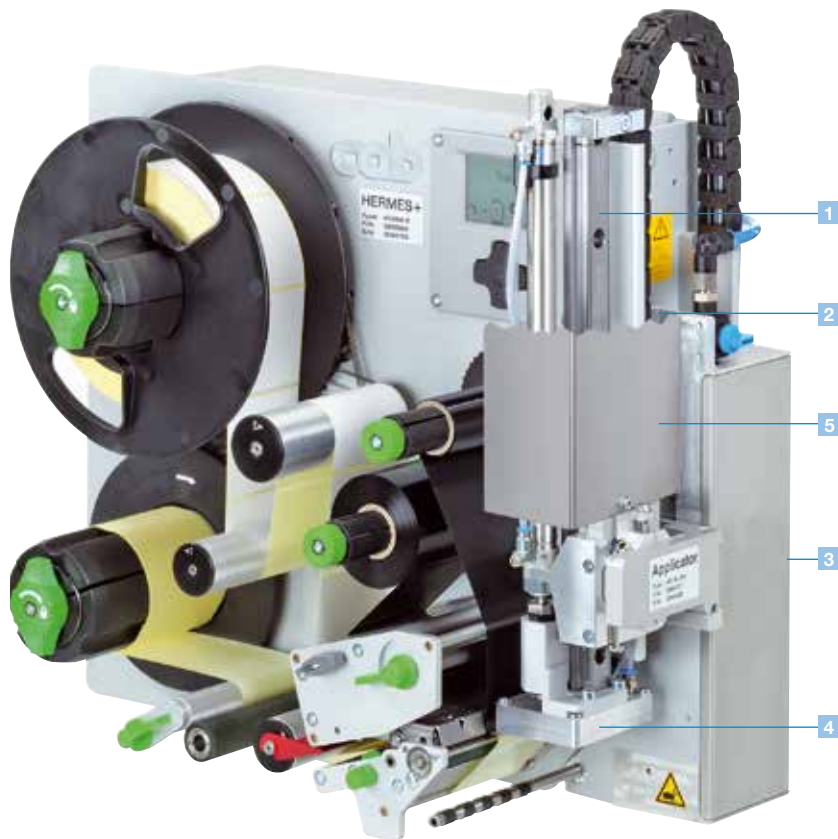

## 1 Long service life

The linear ball-bearing guides are precise and low-wearing.

## 2 Variable product heights

The lifting cylinder allows labeling at different heights. Standard stroke heights are available in 200 / 300 / 400 mm of length. Others are available on request.

## 3 High process reliability

Supporting air jet stream, suction air and lifting speed may be adjusted and are controlled via sensors.

## 4 Real time labeling

Applicators for small and big labels. Label with a height of 4–250 mm and a width of 4–174 mm can be applied.

## 5 Protective cover

As a standard, cylinder and guide are protected by a cover. For labeling work stations protective covers are available that are adapted to the product jig.

## 6 Pivot applicator

Easy and fast access to the printer's mechanics for material change or maintenance.

## Compressed air regulator

Reduces the pressure force of the lifting cylinder on the product.



# Overview applicators and transfer modules

Applicators	Hermes+			Transfer modules													
	2	4	6	Universal pad	Tamp pad	Tamp pad with damping pad	Tamp pad with label stop	Blow pad	Silicone form pad	Spring-mounted pad	Spring-mounted universal pad	Roll-on pad	Corner-wrap pad	Peel-off plate	Vacuum belt	Air-jet module	
Order code	11	11	12	61	21	88	31	31	41	51	–	–	–	–	–	90	
5.1 Swing applicator	3214			–	F	F	F	□	–	–	–	–	–	–	–	–	
5.2 Stroke applicator	4114	4116	–	F	F	F	□	□	–	–	–	–	–	–	–	–	
			–	F	F	F	–	□	–	–	–	–	–	–	–	–	
5.3 Stroke-turn applicator	4214			–	F	F	F	□	–	–	–	–	–	–	–	–	
5.4 Stroke applicator	4414			–	F	F	F	–	–	–	–	–	–	–	–	–	
5.5 Swing-stroke applicator	4514			–	–	–	–	□	–	–	–	–	–	–	–	–	

Product labeling

5.7 Front-side applicator	3014	3016	–	□	–	–	□	–	–	□	–	–	–	–	–	–
			–	□	–	–	–	–	–	□	–	–	–	–	–	–
5.8 Stroke applicator	4014	4016	□	F	–	–	□	–	□	□	□	□	–	–	–	–
			–	□	–	–	–	–	–	□	□	–	–	–	–	–
5.9 Stroke-blow applicator	4614			–	–	–	–	□	–	–	–	–	–	–	–	–
5.10 Demand module	5114			–	–	–	–	–	–	–	–	–	–	□	–	–
5.11 Vacuum-belt applicator	5314	5316		–	–	–	–	–	–	–	–	–	–	–	□	–
5.12 Air-jet box	6014			–	–	–	–	–	–	–	–	–	–	–	–	□

Labeling of packaging

## Type code applicator

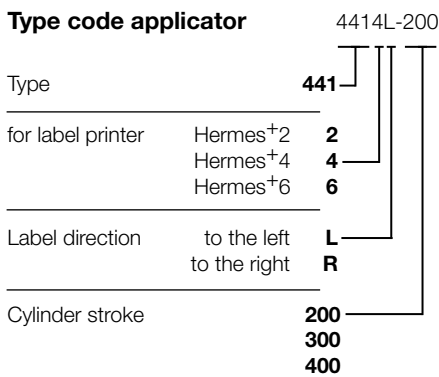

Immersion depth of pad in mm.  
Allows the immersion of the tamp pad into the surface of the label.

# Product marking

## Swing applicator 3214

5.1



For precise real-time labeling of very small to medium sized labels. Preferred method is to apply the labels from the side. The pad is positioned in front of the peel-off plate. The label is held by the applicator during the printing process. A rotating cylinder turns to the labeling position. The label is positioned onto the product via stroke cylinder. Pivoting angle and linear stroke are adjustable.



### Tamp pad

Labels are precisely applied on flat, even recessed surfaces.



### Tamp pad with damping pad

The damping pad is used to reduce noise produced by hard surfaces and is specially suitable for surfaces with rough structure or slightly uneven.

### Tamp pad with label stop

For applying small labels the label stop ensures a very precise positioning onto the product.



### Blow pad

For pressure-sensitive surfaces or products in motion. The labels are applied via air jet onto the product. The distance of 5-10mm to the product surface is set with a stop at the stroke cylinder.

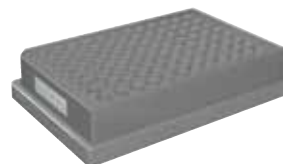

Technical data			Tamp pad	Tamp pad with damping pad	Tamp pad with label stop	Blow pad
			3214 L/R 11 F	3214 L/R 12 F	3214 L/R 61 F	3214 L/R 2100
Label width	Hermes+2	mm	4-58	10-58	10-58	10-58
	Hermes+4	mm	10-114	10-114	10-114	10-80
Label height	Hermes+2	mm	5-80	8-80	5-80	10-80
	Hermes+4	mm	8-80	8-80	8-80	10-80
Product	not in motion during labeling		■	■	■	■
	in motion during labeling		-	-	-	■
Labeling onto the product	from the side		■	■	■	■
Product height	fixed		■	■	■	■
Distance of product to peel-off plate	mm		250-280	250-280	250-280	250-280
Horizontal linear guides	mm		5-30	5-30	5-30	5-30
Pivoting angle			45°-95°	45°-95°	45°-95°	45°-95°
Immersion depth pad F	up to mm		30	30	30	-
Air pressure supply	bar		4,5	4,5	4,5	4,5
Cycle time <sup>1)</sup>	approx. cycles/min.		20	20	20	20

<sup>1)</sup> Calculated at label height 40 mm, print speed 100 mm/s

# Product marking

## Stroke applicator 4114 / 4116

5.2



### Tamp pad

Labels are precisely applied on flat, even recessed surfaces.



### Tamp pad with damping pad

The damping pad is used to reduce noise produced by hard surfaces and is specially suitable for surfaces with rough structure or slightly uneven.

### Tamp pad with label stop

For applying small labels the label stop ensures a very precise positioning onto the product.



### Blow pad

For pressure-sensitive surfaces or products in motion. The labels are applied via air jet onto the product. The distance of 5-10mm to the product surface is set with a stop at the stroke cylinder.

For precise real-time labeling of very small to medium sized labels. Labels may be applied on the product from all sides. The pad is positioned in front of the peel-off plate. The label is held by the applicator during the printing process. A short stroke cylinder moves the label horizontally to the labeling position and places the label on the product. The length of the stroke cylinder defines the maximum distance from the peel-off plate to the product.



Technical data			Tamp pad	Tamp pad with damping pad	Tamp pad with label stop	Blow pad
			4114/16 L/R 11 F	4114/16 L/R 12 F	4114/16 L/R 61 F	4114 L/R 2100
Label width	Hermes+2	mm	4-58	10-58	10-58	10-58
	Hermes+4	mm	10-114	10-114	10-114	10-114
	Hermes+6	mm	50-174	50-174	50-174	-
Label height	Hermes+2	mm	4-80	8-80	4-80	10-80
	Hermes+4	mm	8-80	8-80	8-80	10-80
	Hermes+6	mm	8-80	8-80	8-80	-
Product	not in motion during labeling		■	■	■	■
	in motion during labeling		-	-	-	■
Labeling onto the product	from top		■	■	■	■
	from below		■	■	■	■
	from the side		■	■	■	■
Product height	fixed		-	-	-	■
	variable		■	■	■	-
Horizontal short stroke cylinder	mm	10	10	10	10	
Product distance to lower edge at cylinder stroke	200	up to mm	135	135	135	140
	300	up to mm	235	235	235	240
	400	up to mm	335	335	335	340
Immersion depth pad F <sup>2)</sup>	up to mm	100	100	100	-	
Air pressure supply	bar	4,5	4,5	4,5	4,5	
Cycle time <sup>1)</sup>	l approx. cycles/min.	30	30	30	30	

<sup>1)</sup> Calculated at stroke 100 mm below device, label height 40 mm, print speed 100 mm/s  
<sup>2)</sup> If immersion depth at applicator > 25 mm, the cover of the Hermes+ has to be modified.

# Product marking

## Stroke applicator 4114 / 4116

5.2



For precise real-time labeling of very small to medium sized labels. Labels may be applied on the product from all sides. The pad is positioned in front of the peel-off plate. The label is held by the applicator during the printing process. A short stroke cylinder turns the tamp pad horizontally into the labeling position and places the label onto the product. The length of the stroke cylinder defines the maximum distance from the peel-off plate to the product.



### Silicone form pad

Labels are precisely applied on cylindrical bodies, curved and inclined surfaces. Curved silicone form pads are used to avoid blistering on very smooth and flat surfaces. Cylindrical bodies may be wrapped up to 200°.

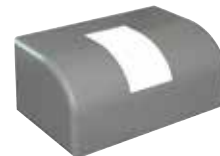

Technical data			Silicone form pad	
			4114/16 L/R 8800	
Label width	Hermes+2	mm	10–58	
	Hermes+4	mm	10–114	
	Hermes+6	mm	50–174	
Label height		mm	8–80	
Product	not in motion during labeling		■	
	in motion during labeling		-	
Labeling onto the product	from top		■	
	from below		■	
	from the side		■	
Product height	variable		■	
Horizontal short stroke cylinder		mm	10	
Product distance to lower edge at cylinder stroke	200	up to mm	135	
	300	up to mm	235	
	400	up to mm	335	
Air pressure supply		bar	4,5	
Cycle time <sup>1)</sup>	approx. cycles/min.		20	

<sup>1)</sup> Calculated at stroke 100 mm below device, label height 40 mm, print speed 100 mm/s  
If height of silicone form pad > 25 mm, the cover of the Hermes+ has to be modified.

# Product marking

## Stroke-turn applicator 4214

5.3



### Tamp pad

Labels are precisely applied on flat, even recessed surfaces.



### Tamp pad with damping pad

The damping pad is used to reduce noise produced by hard surfaces and is specially suitable for surfaces with rough structure or slightly uneven.

### Tamp pad with label stop

For applying small labels the label stop ensures a very precise positioning onto the product.



### Blow pad

For pressure-sensitive surfaces or products in motion. Labels are applied via air jet onto the product. The distance of 5-10mm to the product surface is set with a stop at the stroke cylinder.

For precise real-time labeling of very small to medium sized labels in case of difficult installation positions. Labels may be applied on the product from all sides.

The pad is positioned in front of the peel-off plate.

The label is held by the applicator during the printing process.

A rotating cylinder turns the label horizontally and up to 180°

into the labeling position and places the label on the product.

The length of the stroke cylinder defines the maximum distance from the peel-off plate to the product.



Technical data			Tamp pad	Tamp pad with damping pad	Tamp pad with label stop	Blow pad
			4214 L/R 11 F	4214 L/R 12 F	4212 L/R 61 F	4214 L/R 2100
Label width	Hermes+2	mm	4-58	10-58	10-58	10-58
	Hermes+4	mm	10-80	10-80	10-80	10-80
Label height	Hermes+2	mm	4-40	8-40	4-40	10-40
	Hermes+4	mm	8-40	8-40	8-40	10-40
Product	not in motion during labeling		■	■	■	■
	in motion during labeling		-	-	-	■
Labeling onto the product	from top		■	■	■	■
	from below		■	■	■	■
	from the side		■	■	■	■
Product height	fixed		-	-	-	■
	variable		■	■	■	-
Horizontal pivoting angle	90°, 180°, 0°		■	■	■	■
Product distance to lower edge at cylinder stroke	200	up to mm	135	135	135	140
	300	up to mm	235	235	235	240
	400	up to mm	335	335	335	340
Immersion depth pad F <sup>2)</sup>	up to mm		65	65	65	-
Air pressure supply	bar		4,5	4,5	4,5	4,5
Cycle time <sup>1)</sup>	approx. cycles/min.		20	20	20	20

<sup>1)</sup> Calculated at stroke 100 mm below device, label height 40 mm, print speed 100 mm/s

<sup>2)</sup> If immersion depth at applicator > 25 mm the cover of the Hermes+ has to be modified.

# Product marking

## Stroke applicator 4414

5.4



For precise real-time labeling of very small to medium sized labels. Final positioning onto the product is adjustable in X- and Y direction. Labels may be applied on the product from all sides. The pad is positioned in front of the peel-off plate. The label is held by the applicator during the printing process. Two short stroke cylinders move the pad horizontally into the labeling position and place the label on the product. The length of the stroke cylinder defines the maximum distance from the peel-off plate to the product.



### Tamp pad

Labels are precisely applied on flat, even recessed surfaces.



### Tamp pad with damping pad

The damping pad is used to reduce noise produced by hard surfaces and is specially suitable for surfaces with rough structure or slightly uneven.

### Tamp pad with label stop

For applying small labels the label stop ensures a very precise positioning onto the product.



Technical data			Tamp pad	Tamp pad with damping pad	Tamp pad with label stop
			4414 L/R 11 F	4414 L/R 12 F	4414 L/R 61 F
Label width	Hermes+2	mm	4–58	10–58	10–58
	Hermes+4	mm	10–114	10–114	10–114
Label height	Hermes+2	mm	4–80	8–80	4–80
	Hermes+4	mm	8–80	8–80	8–80
Product	not in motion during labeling		■	■	■
Labeling onto the product	from top		■	■	■
	from below		■	■	■
	from the side		■	■	■
Product height	variable		■	■	■
Horizontal short stroke cylinder	x-direction		3–7	3–7	3–7
	y-direction		11–15	11–15	11–15
Product distance to lower edge at cylinder stroke	200	up to mm	135	135	135
	300	up to mm	235	235	235
	400	up to mm	335	335	335
Immersion depth pad F <sup>2)</sup>	up to mm		90	90	90
Air pressure supply	bar		4,5	4,5	4,5
Cycle time <sup>1)</sup>	approx. cycles/min.		25	25	25

<sup>1)</sup> Calculated at stroke 100 mm below device, label height 40 mm, print speed 100 mm/s

<sup>2)</sup> If immersion depth at applicator > 25 mm, the cover of the Hermes+ has to be modified



# Product marking

## Swing-stroke applicator 4514

5.5



For precise real-time labeling at the inner surface of profiles and pipes. Precise position of the label is adjusted with a stop at the stroke cylinder. Labels may be applied on the product from all sides. The blow pad is positioned in front of the peel-off plate. The label is held by the applicator during the printing process. A rotating cylinder turns the pad into the labeling level. The stroke cylinder moves the label into the labeling position.



### Blow pad

Labels are blown onto the product via air jet with a distance of 5 – 10 mm to the product surface.



Technical data			Blow pad	
			4514 L/R 2100	
Label width	Hermes+2	mm	10–58	
	Hermes+4	mm	10–80	
Label height		mm	10–60	
Product	not in motion during labeling		■	
Labeling onto the product	from top		■	
	from below		■	
	from the side		■	
Product height	fixed		■	
Vertical pivoting angle			120°	
Distance lower edge device to upper edge label at cylinder stroke	200	up to mm	150 <sup>2)</sup>	
	300	up to mm	250 <sup>2)</sup>	
	400	up to mm	350 <sup>2)</sup>	
Air pressure supply	bar		4,5	
Cycle time <sup>1)</sup>	approx. cycles/min.		20	

<sup>1)</sup> Calculated at stroke 100 mm below device, label height 40 mm, print speed 100 mm/s

<sup>2)</sup> Depending on label height



# Packaging marking

## Front-side applicator 3014 / 3016

5.7

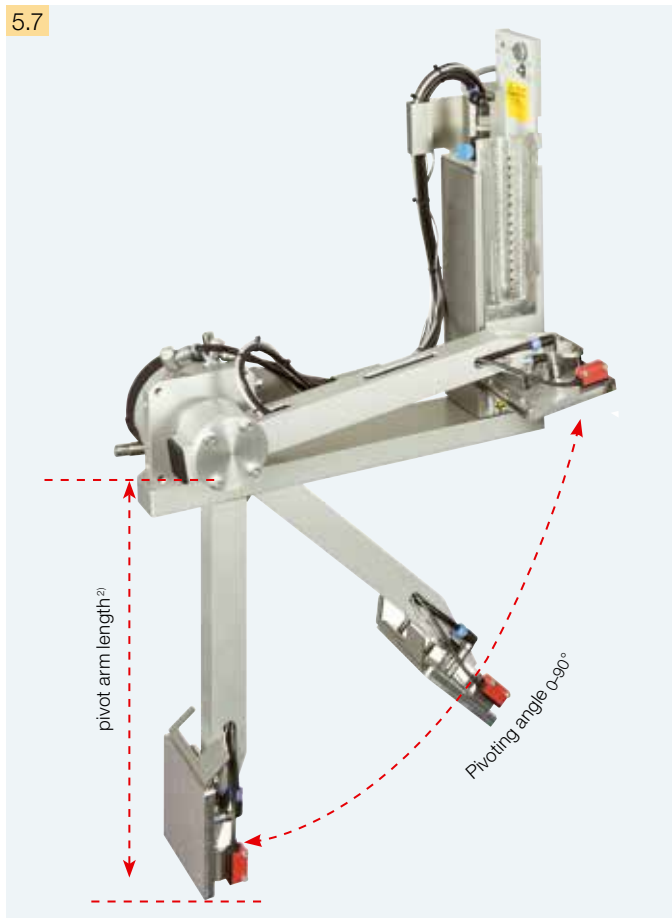

Labels are applied on the product via rotating cylinder. A sensor enables the detection of the packaging and to control the pivot arm and tamp pad moving to their initial position after labeling.

### Tamp pad

Labels are precisely applied on flat, even recessed surfaces.



### Spring-mounted tamp pad

The spring-mounted suction plate enables labeling on inclined surfaces up to 15°. Vertical deviation can be up to 10 mm within the label area.



### Blow pad

Labels are blown onto the product via air jet with a distance of 5 – 10 mm to the product surface.

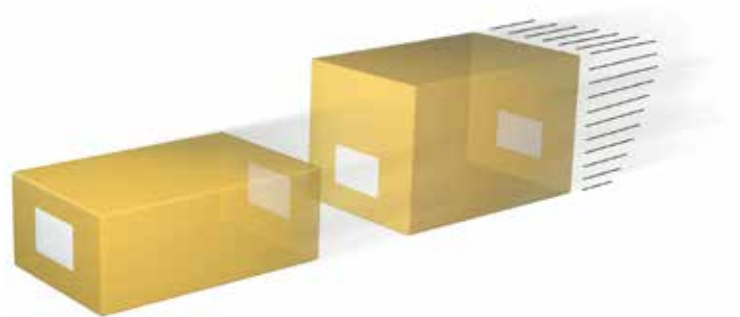

For real-time labeling on packaging in motion. Preferred method is to apply the labels on the front or back of the product. Labeling from above or from the side is possible. The pad is positioned in front of the peel-off plate. The label is held by the applicator during the printing process.

Technical data			Tamp pad	Spring-mounted tamp pad	Blow pad
			3014/16 L/R 1100	3014/16 L/R 3100	3014 L/R 2100
Label width	Hermes+4	mm	25 – 114	80 – 114	25 – 114
	Hermes+6	mm	25 – 174	80 – 174	–
Label height	Hermes+4	mm	8 – 250	80 – 250	10 – 100
	Hermes+6	mm	25 – 250	80 – 250	25 – 100
Product	not in motion during labeling		■	■	■
	in motion during labeling		■	■	■
Labelling onto the product	from top		■	■	■
	from the side		■	■	■
	from the front		■	■	■
	from the back		■	■	■
Product height	variable		■	■	
Pivot arm length <sup>1)</sup>	mm	200/300/400	200/300/400	200/300/400	
Pivoting angle		0 – 90°	0 – 90°	0 – 90°	
Air pressure supply	bar	4,5	4,5	4,5	
Cycle time <sup>1)</sup>	approx. cycles/min.	15	15	15	

<sup>1)</sup> Calculated at length pivot arm length 200 mm, label height 40 mm / print speed 100 mm/s

<sup>2)</sup> Pivot arm length is defined as achievable label position under 90° (lower edge label format) measured from the base area of Hermes+

# Packaging marking

## Stroke applicator 4014 / 4016

5.8



For real-time labeling on packaging or products. According to the type of pad the product is either in or not in motion. Labels may be applied from all sides. The pad is positioned in front of the peel-off plate. The label is held by the applicator during the printing process. The stroke cylinder places the label onto the product. A sensor enables to detect the product and to control the tamp pad moving to its initial position after labeling. The length of the stroke cylinder defines the maximum distance from the peel-off plate to the product.



### Tamp pad

Labels are precisely applied on flat, even recessed surfaces.



### Universal pad

Labels are applied onto even surfaces. The vacuum holes providing suction to the labels are pilot holes placed in a distance of 5 mm and covered with sliding film. These are opened according to the label size using a punching tool. Two spare sliding films are included in the scope of delivery.



### Spring-mounted tamp pad

The spring-mounted vacuum plate enables labeling on curved surfaces up to 15°. Vertical deviation may be up to 10 mm within the label area.



### Spring-mounted universal pad

The spring-mounted vacuum plate enables labeling on curved surfaces up to 15°. Vertical deviation may be up to 10mm within the label area. The vacuum holes providing suction to the labels are pilot holes placed in a distance of 5 mm and covered with sliding film. Two spare sliding films are included in the scope of delivery.



Technical data			Tamp pad	Universal pad	Spring-mounted tamp pad	Spring-mounted universal pad
			4014/16 L/R 11 F	4014 L/R 1100	4014/16 L/R 3100	4014 L/R 3100
Label width	Hermes+4	mm	20–114	75 / 90	80–114	116 / 116
	Hermes+6	mm	50–174	–	80–174	–
Label height	Hermes+4	mm	20–210	60 / 90	80–210	102 / 152
	Hermes+6	mm	25–210	–	80–210	–
Product	not in motion during labeling		■	■	■	■
Labeling onto the product	from top		■	■	■	■
	from below		■	■	■	■
	from the side		■	■	■	■
Product height	variable		■	■	■	■
Product distance to lower edge at cylinder stroke	200	up to mm	135	135	130	130
	300	up to mm	235	235	230	230
	400	up to mm	335	335	330	330
Immersion depth pad F <sup>2)</sup>	up to mm		120	–	–	–
Air pressure supply	bar		4,5	4,5	4,5	4,5
Cycle time <sup>1)</sup>	approx. cycles/min.		25	25	25	25

<sup>1)</sup> Calculated at stroke 100 mm below device, label height 100 mm, print speed 100 mm/s

<sup>2)</sup> If immersion depth at applicator > 25 mm, the cover of the Hermes+ has to be modified

# Packaging marking

## Stroke applicator 4014 / 4016

5.8



### Blow pad

For pressure-sensitive surfaces or products in motion. Labels are applied via air jet onto the product. The distance of 5-10mm to the product surface is set with a stop at the stroke cylinder.



### Roll-on pad

Labels are rolled on flat product surfaces during their transport.



### Corner-wrap pad

Labels are applied on two adjacent product sides. The tamp pad applies the first half on top side of the product and then the second half of the label is rolled on.

For real-time labeling on packaging or products. According to the type of pad the product is either in or not in motion. Labels may be applied from all sides. The pad is positioned in front of the peel-off plate. The label is held by the applicator during the printing process. The stroke cylinder places the label onto the product. A sensor enables to detect the product and to control the tamp pad moving to its initial position after labeling. The length of the stroke cylinder defines the maximum distance from the peel-off plate to the product.



Technical data			Blow pad	Roll-on pad	Corner-wrap pad
			4014 L/R 2100	4014/16 L/R 4100	4014 L/R 5100
Label width	Hermes+4	mm	20–114	25–114	20–114
	Hermes+6	mm	–	50–174	–
Label height	Hermes+4	mm	20–100	80–250	60–210
	Hermes+6	mm	–	80–250	–
Product	not in motion during labeling		■	–	■
	in motion during labeling		■	■	–
Labeling onto the product	from top		■	■	■
	from below		■	■	–
	from the side		■	■	–
Product height	fixed		■	–	–
	variable		–	■	■
Product distance to lower edge at cylinder stroke	200	up to mm	140	160	100
	300	up to mm	240	260	200
	400	up to mm	340	360	300
Air pressure supply		bar	4,5	4,5	4,5
Cycle time <sup>1)</sup>		approx. cycles/min.	25	20	20

<sup>1)</sup> Calculated at stroke 100 mm below device, label height 100 mm, print speed 100 mm/s

# Packaging marking

## Stroke-blow applicator 4614

5.9



For real-time labeling of packaging differing in height and being in motion. Labels may be applied from all sides. The blow pad is positioned in front of the peel-off plate. The label is held by the applicator during the printing process. The stroke cylinder moves the tamp pad controlled via sensor about 10 mm above the product. The length of the stroke cylinder defines the maximum differences in height of the packaging.



### Blow pad

Labels are blown onto the product via air jet with a distance of 5 – 10 mm to the product surface.



Technical data			Blow pad	
			4614 L/R 2100	
Label width	Hermes+4	mm	20 – 114	
	Hermes+6	mm	on request	
Label height	Hermes+4	mm	20 – 100	
	Hermes+6	mm	on request	
Product	not in motion during labeling		■	
	in motion during labeling		■	
Labeling onto the product	from top		■	
	from below		■	
	from the side		■	
Product height	fixed		■	
	variable		■	
Product distance to lower edge at cylinder stroke	200	up to mm	140	
	300	up to mm	240	
	400	up to mm	340	
Air pressure supply		bar	4,5	
Cycle time <sup>1)</sup>		approx. cycles/min.	25	

<sup>1)</sup> Calculated at stroke 100 mm below device, label height 100 mm, print speed 100 mm/s

# Packaging marking

## Demand module 5114

5.10



For serial labeling of packaging in motion. The variable guide pulley enables to adjust the label position at the dispensing tongue. Labels may be applied from all sides. Printing and labeling is done simultaneously. Speed of the conveyor belt needs to be adapted to the print speed.

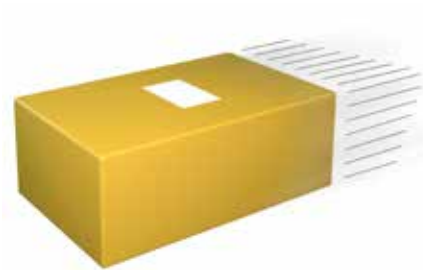

Technical data	Demand module 5114	
Label width Hermes+4	mm	25–114
Label height	mm	25–250
Product	in motion during labeling	■
Labeling onto the product	from top	■
	from below	■
	from the side	■
Product height	fixed	■
Product distance to lower edge	mm	80
Product speed	mm/s	needs to correspond to the print speed / 50–250 in steps of 25
Cycle time <sup>1)</sup>	approx. cycles/min.	60

<sup>1)</sup>Label height 100 mm, print speed 100 mm/s

# Packaging marking

## Vacuum-belt applicator 5314 / 5316

5.11

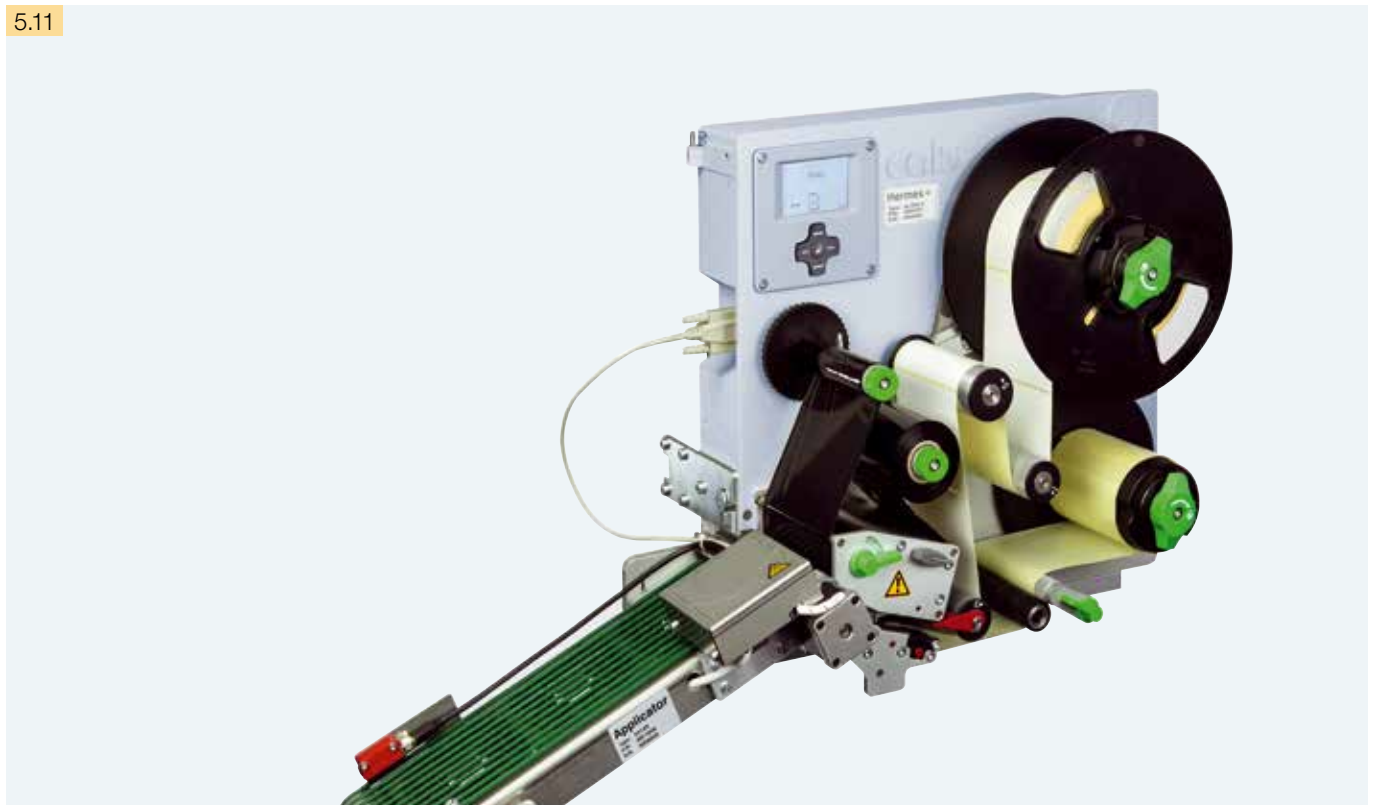

For real-time labeling of packaging in motion. The printed label is moved into the labeling position via vacuum-belt and applied on the packaging via external signal. Labels may be applied from all sides. Printing and labeling may be done simultaneously. The conveyor speed is not related to the print speed.



Technical data			Vacuum-belt applicator 5314 <sup>1)</sup>	Vacuum-belt applicator 5316 <sup>1)</sup>
Label width	Hermes+4	mm	20–114	–
	Hermes+6	mm	–	50–174
Label height		mm		70–320
Product	in motion during labeling		■	
Labeling onto the product	from top		■	
	from below		■	
	from the side		■	
Product distance	fixed		■	
Speed vacuum-belt	mm/s		100 / 150 / 220 / 300	
Length vacuum-belt	mm		390	
Cycle time <sup>2)</sup>	approx. cycles/min.		30	

<sup>1)</sup> Not to be combined with Hermes+ cover

<sup>2)</sup> Label height 100 mm, print speed 100 mm/s



# Packaging marking

## Air-jet-box 6014

5.12



### Air-jet module

Pre-drilled holes provide suction and blow capabilities. The blow tubes are aligned on the pad based on the label size. The outer area around the label is covered with film. The blow box pad may be easily exchanged for different label sizes.



For fast real-time labeling of packaging or products in motion. Preferred method is to apply the labels from top. Labels are sucked with a fan and blown off by nozzels via powerful air jet. Distance from lower edge of the device to the product is, according to the label size, up to 100 mm.



Technical data		Air-jet module 6014 L/R 9000	
Label width	Hermes+4 mm	50–114	
Label height	mm	50–150	
Product	not in motion during labeling	■	
	in motion during labeling	■	
Labeling onto the product	from top	■	
	from the side	■	
Product height	variable	■	
Product distance to lower edge	mm	10–100	
Air pressure	bar	4,5	
Cycle time <sup>1)</sup>	approx. cycles/min.	60	

<sup>1)</sup> Calculated at label height 80 mm

# Overview accessories









■ Standard □ Option







Extras Hermes <sup>+</sup>		Hermes <sup>+</sup> 2	Hermes <sup>+</sup> 4	Hermes <sup>+</sup> 6
2.1	Cover (only for label rolls up to 205 mm Ø)	<input type="checkbox"/>	<input type="checkbox"/>	<input type="checkbox"/>
2.2	External operation panel	<input type="checkbox"/>	<input type="checkbox"/>	<input type="checkbox"/>
2.3	Standard keyboard USB	<input type="checkbox"/>	<input type="checkbox"/>	<input type="checkbox"/>
2.4	Memory card CompactFlash Type I	<input type="checkbox"/>	<input type="checkbox"/>	<input type="checkbox"/>
2.5	Photo sensor to start 25 pole connection Hermes+	<input type="checkbox"/>	<input type="checkbox"/>	<input type="checkbox"/>
2.6	Photo sensor to start 3 pole connection circular connector air-jet box			
2.7	I/O Interface connector SUB-D-plug 25 pole	<input type="checkbox"/>	<input type="checkbox"/>	<input type="checkbox"/>
2.8	Warning light	<input type="checkbox"/>	<input type="checkbox"/>	<input type="checkbox"/>
2.9	Circular connector 3-pin/4-pin M8	<input type="checkbox"/>	<input type="checkbox"/>	<input type="checkbox"/>
Interfaces				
3.1	Centronics bi-directional acc. to IEEE 1284	<input type="checkbox"/>	<input type="checkbox"/>	<input type="checkbox"/>
3.2	RS422/RS485 1.200 up to 230.400 baud/8 bit	<input type="checkbox"/>	<input type="checkbox"/>	<input type="checkbox"/>
3.3	Label selection – I/O-box	<input type="checkbox"/>	<input type="checkbox"/>	<input type="checkbox"/>
3.4	I/O interface adapter	<input type="checkbox"/>	<input type="checkbox"/>	<input type="checkbox"/>
Connecting cable				
4.1	Connecting cable RS232 C, 9/9-pin, length 3 m	<input type="checkbox"/>	<input type="checkbox"/>	<input type="checkbox"/>
4.2	Patch cable CAT 5e, length 3 m, grey	<input type="checkbox"/>	<input type="checkbox"/>	<input type="checkbox"/>





Extras applicators		Type	30	32	40	41	42	44	45	46	60
5.13	Blow tube cpl.		<input type="checkbox"/>	<input type="checkbox"/>	<input type="checkbox"/>	<input type="checkbox"/>	<input type="checkbox"/>	<input type="checkbox"/>	<input type="checkbox"/>	<input type="checkbox"/>	<input type="checkbox"/>
5.14	Air pressure regulation unit		<input type="checkbox"/>	<input type="checkbox"/>	<input type="checkbox"/>	<input type="checkbox"/>	<input type="checkbox"/>	<input type="checkbox"/>	<input type="checkbox"/>	<input type="checkbox"/>	<input type="checkbox"/>
5.15	Air pressure regulation unit with main valve		<input type="checkbox"/>	<input type="checkbox"/>	<input type="checkbox"/>	<input type="checkbox"/>	<input type="checkbox"/>	<input type="checkbox"/>	<input type="checkbox"/>	<input type="checkbox"/>	<input type="checkbox"/>
5.16	Air pressure regulation unit with shut-off valve		<input type="checkbox"/>	<input type="checkbox"/>	<input type="checkbox"/>	<input type="checkbox"/>	<input type="checkbox"/>	<input type="checkbox"/>	<input type="checkbox"/>	<input type="checkbox"/>	<input type="checkbox"/>
5.17	Compressed air regulator		—	<input type="checkbox"/>	<input type="checkbox"/>	<input type="checkbox"/>	<input type="checkbox"/>	<input type="checkbox"/>	—	—	—

Assembly aids		Hermes <sup>+</sup> 2	Hermes <sup>+</sup> 4	Hermes <sup>+</sup> 6
6.1	Adapter plate	<input type="checkbox"/>	<input type="checkbox"/>	<input type="checkbox"/>
6.2	Profile 40 / 80 / 120 mm	<input type="checkbox"/>	<input type="checkbox"/>	<input type="checkbox"/>
6.3	Base plate 500 x 255	<input type="checkbox"/>	<input type="checkbox"/>	—
6.4	Mounting plate	<input type="checkbox"/>	<input type="checkbox"/>	<input type="checkbox"/>
6.5	Bracket	<input type="checkbox"/>	<input type="checkbox"/>	<input type="checkbox"/>
6.6	Clamped joint for profile 50 x 50 mm	<input type="checkbox"/>	<input type="checkbox"/>	<input type="checkbox"/>
6.7	Flanged joint for profile 50 x 50 mm	<input type="checkbox"/>	<input type="checkbox"/>	<input type="checkbox"/>
6.8	Stand 1601	<input type="checkbox"/>	<input type="checkbox"/>	<input type="checkbox"/>
6.9	Stand 1602	<input type="checkbox"/>	<input type="checkbox"/>	<input type="checkbox"/>
Software				
7.1	J-Script direct programming	■	■	■
7.2	Replace files and integration in SAP R/3	■	■	■
7.3	abc-Basic-Compiler	■	■	■
7.4	Printer monitoring with Intra- and Internet	■	■	■
7.5	Database Connector	■	■	■
7.6	Label software cablabel® S3 Lite	■	■	■
	Label software cablabel® S3 Pro	<input type="checkbox"/>	<input type="checkbox"/>	<input type="checkbox"/>
	Label software cablabel® S3 Print	<input type="checkbox"/>	<input type="checkbox"/>	<input type="checkbox"/>
7.7	Administration Network Manager	■	■	■
7.8	Printer driver Windows	■	■	■
7.9	Printer driver Apple-MAC/Linux	■	■	■
7.10	Programmer's guide	■	■	■

# Accessories

Extras Hermes+	Product
2.1 	<b>Cover</b> Protecting the Hermes+ from dirt and against accidental contact. If the immersion depth of the applicator exceeds 25mm the cover has to be modified. The cover is approved for the vertical installation position.
2.2 	<b>External operation panel</b> If the operation panel is not accessible after installation of the printer an external operation panel may additionally be connected. There is also a slot for CF Card Type 1 and USB host interface.
2.3 	<b>Standard keyboard USB</b> Connection: USB, number of keys: 115
2.4 	<b>Memory card</b> CompactFlash Typ I. Storing label formats, fonts, texts Graphics are read- and writeable either on the printer or on the PC
2.5 	<b>Product sensor to start 25 pin</b> Connection Hermes+. Start of printing and applying after detection of a product, e.g. on a conveyor belt.
2.6 	<b>Product sensor 3 pin</b> Connection applicator. Start of printing and applying after detection of a product, e.g. on a conveyor belt.
2.7 	<b>Interface connector Sub-D plug</b> With screw terminals for connecting all control signals at the IO-interface Hermes+
2.8 	<b>Warning light</b> Indicates the display and additionally the printer status. <b>Red:</b> Printing or applying error <b>Yellow:</b> Prewarning end of label, end of ribbon <b>Green:</b> Ready for operation The warning light is mounted directly at the printer, bracket or somewhere in the surrounding area. Length of connection cable 1 m.
2.9 	<b>Circular connector</b> 3-pin M8 / 4-pin M8

Interfaces	Product
3.1 	<b>Interface Centronics</b> bi-directional acc. to IEEE 1284
3.2 	<b>Interface RS422/RS485</b> 1.200 up to 230.400 baud/8 bit
3.3 	<b>Label selection – I/O-Box</b> Via PLC up to 16 different labels can be selected from the memory card.
3.4 	<b>I/O interface adapter</b> It adapts the 15 pin connector of a Hermes A labeling system to the 25 pin connector of Hermes+.
Connecting cable	Product
4.1 	<b>Connecting cable RS232 C</b> 9/9-pin, length 3 m
4.2 	<b>Patch cable CAT 5e</b> , 3 m, grey

Extras Applicators	Product
5.13 	<b>Blow tube</b>
5.14 	<b>Air pressure regulation unit</b> It can be mounted at the Hermes+ or bracket according to angle. Presetting at 4,5 bar.
5.15 	<b>Air pressure regulation unit</b> With main valve. In case of integration of the print & apply system into a production line the air-pressure for the applicator may be switched on or off externally. Presetting at 4,5 bar. Essential in combination with E-Stop switch.
5.16 	<b>Air pressure regulation unit</b> With additional shut-off valve to allow complete ventilation of hose lines behind the air pressure regulation unit for using the air-jet box 6014.
5.17 	<b>Compressed air regulator</b> To reduce tamp force of stroke applicators.

## Accessories - Assembly aids



### Mounting foot

For desktop installation or integration into production lines, Available in left or right version. Size of the foot may upon request be adapted to the requirements of the application.

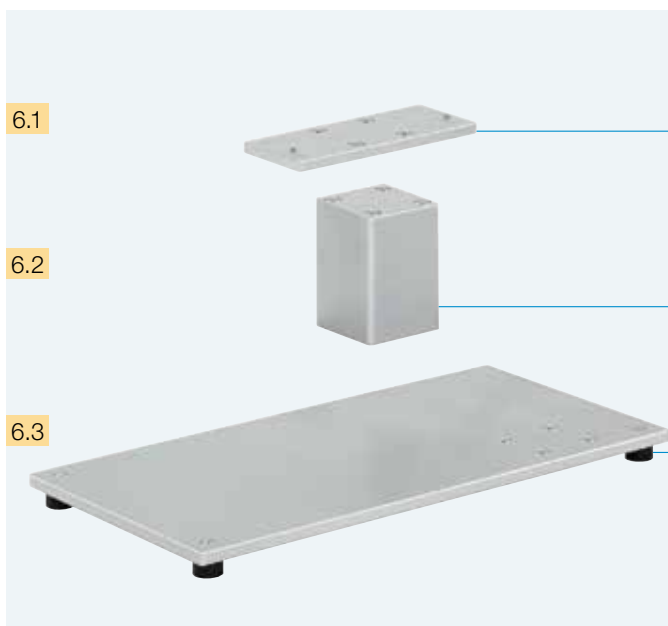

6.1

### 1 Adapter plate

The device is mounted on the adapter plate. The printer with adapter plate may also be mounted directly at the production line by using the profile.

6.2

### 2 Profile

Standard lengths: 40, 80 and 120 mm. The aluminum square profile may also be customized in length according to the individual requirements. Other lengths on request.

6.3

### 3 Base plate

For fastening the printer holder  
Standard size: 500 x 255 mm.



6.4

### Mounting plate

Allows to mount the device directly at the production line.

## Accessories - Mounting aid

6.5



### Bracket

The Hermes+ is mounted at the stand via bracket.

6.6

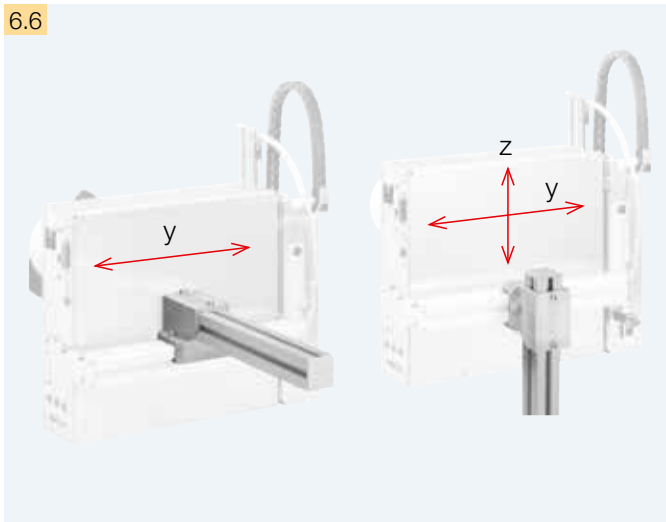

### Clamped joint for profile 50 x 50 mm

With this clamped joint the labeling system can be moved horizontally and vertically.

6.7

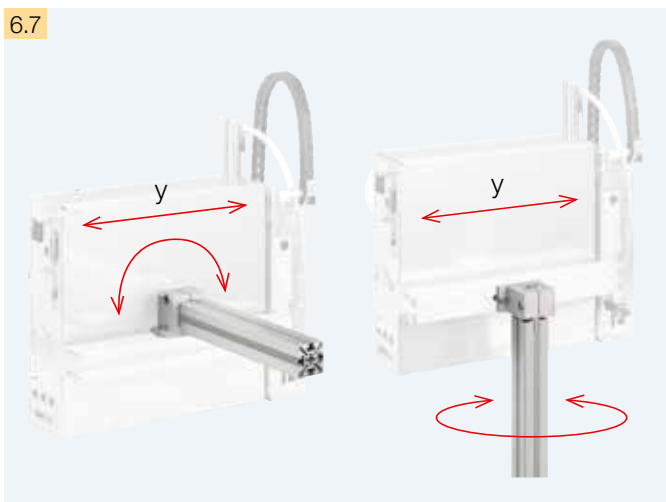

### Flanged joint for profile 50 x 50 mm

Allows the device to be moved in horizontal direction or to be rotated about one axis.

# Accessories floor stand

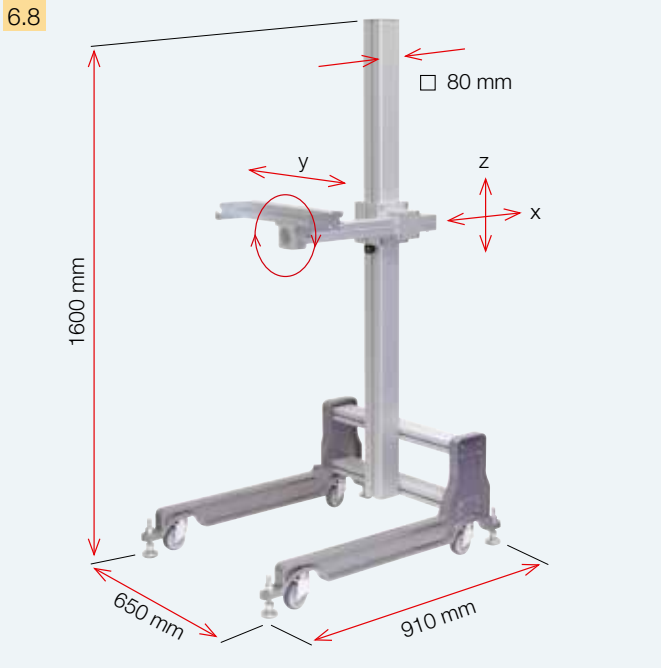

For integrating all types of labeling systems of the Hermes+ series into any manufacturing line. Due to the adjustability the Hermes+ can be positioned in 3 axes to the product to be labeled. Pivoting is also possible.

## Floor stand 1601 Hermes+

Preferred for using the Hermes+ at different production lines. The floor stand is mobile and allows to be positioned and locked with adjustable feet at the place of destination.

Technical data	Floor stand 1601 Hermes+
Base frame	Guide rollers and adjustable feet
Adjustment in height	Screw clamping
Adjustment in depth	Screw clamping
Max. load kg at an offset of 500 mm	50
Weight kg	36



## Floor stand 1602 Hermes+

Preferably used if the labeling position needs to be frequently adjusted in height and depth. Due to the toothed rack adjustment the Hermes+ may be positioned in X and Y direction to the product.

Technical data	Floor stand 1602 Hermes+
Base frame	Adjustable feet
Adjustment in height	Toothed rack / crank
Adjustment in depth	Toothed rack / handwheel
Max. load kg at an offset of 500 mm	50
Weight kg	38

## Examples printer installation

Labeling in transport direction from top

sidewards



Labeling at right angles to transport direction from top

sidewards



# Software features of the label printer

## 7.1

J  
H 100  
O R  
S l1:0,0,68,70,100  
T 10, 10,0,5,pt20;sample  
B 10,20,0,EAN-13,SC2,401234512345  
G 8,3,5,0;R:30,9,0,3;0,3  
A 1

**Job Start**  
**Speed (100 mm / s)**  
**Orientation rotated by 180°**  
**Size of label (100x68 mm, gap 2 mm)**  
**Text object/font: Swiss bold, 20 pt**  
**Barcode EAN 13; size SC 2**  
**Graphic, box 30 x 9 mm,**  
**Line weight 0,3 mm**  
**Number of labels (in this example 1)**

## Direct programming with JScript

Every cab printer can be directly programmed with the easy to understand programming language JScript. JScript is described in the programmer's guide (product range 7.10). The label software cablabel® S3 optimally supports the direct programming, but may also be generated with any other text editor.

## 7.2

### SAP® Member Printer Vendor Program

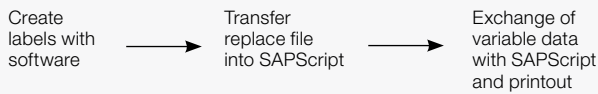

## Replace files and integration in SAP R/3\*

In cooperation with SAP, cab developed the replace method to control cab printers with SAPScript from SAP R/3. As a SAP partner, cab has access to the SAP development area for optimum printer support in SAP environments. With the replace method the host computer only sends data to the device that has to be changed in JScript. cablabel® S3 enables to generate all necessary replace files in combination with the label layout in one software.

*\* SAP and all SAP logos are trademarks or registered trademarks of SAP SE in Germany and in several other countries.*

## 7.3

```

abc - Notepad
File Edit Format View Help
<ABC>
label start
input a$
if left$(a$,15)="-194300301480070" then
  print "R t2:",mid$(a$,16)
endif
if left$(a$,15)="-194300300580172" then
  print "R t3:",mid$(a$,16)
endif
if left$(a$,15)="-194300301970073" then
  print "R t1:",mid$(a$,16)
endif
if a$0"q0001" then
  print "A 1"
endif
goto start
  
```

## abc BASIC Compiler

As an integrated element of the firmware, the Basic Compiler enables the printer to process data via BASIC programming before it is sent for print editing. That way, you replace external printer languages or integrate data from other systems, e.g. balance or a PLC.

With cablabel® S3 you integrate the required program code easily when creating the label.



## 7.4



## Printer monitoring with Intranet and Internet

Using standard programs such as the web browser or FTP clients, the integrated HTTP and FTP server enables print monitoring, configuration, firmware updates and memory card administration. Status, warning and error messages are sent to administrators or users as e-mails or SNMP datagrams via SNMP and SMTP clients. A time server is used to synchronize time and date.

## 7.5



## Database Connector

In the stand-alone mode with additional network connection the Database Connector allows the printer to access data directly from a central ODBC-/OLEDB compatible database and to print it. At the same time, data can also be written back to the database during the printing process.

Integrating the Database Connector into cablabel® S3 allows to conveniently establish this data base connection when designing your layout.

# Software tools – Label software

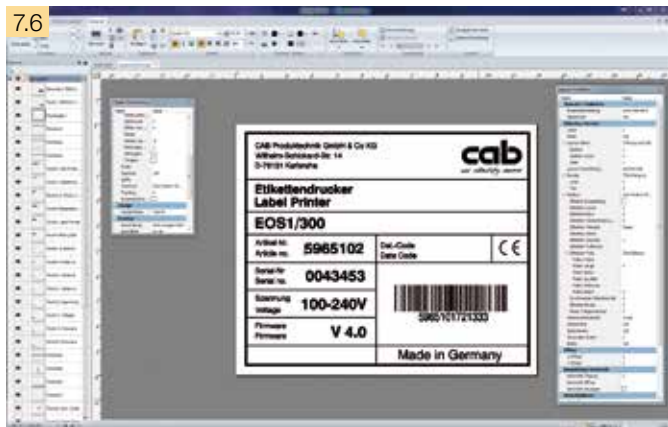

cablabel® S3 is a label software that offers the following three functions:

- **Designing**
- **Printing**
- **Monitoring**

cablabel® S3 does open up the full potential of cab devices in the design of your label: An extensive instruction set is available within the intuitive user interface, e.g. different date formats, mathematic or logic functions.

In doing so, cablabel® S3 brings all cab marking systems together: First of all you design the label. You do not decide until printing whether you like the label to be dispensed on a label printer, a print and apply system or a laser marking system.

cablabel® S3 is available for the following operating systems in 32- and 64-bit version:

- |               |                        |
|---------------|------------------------|
| Windows Vista | Windows Server 2008    |
| Windows 7     | Windows Server 2008 R2 |
| Windows 8     | Windows Server 2012    |
| Windows 8.1   | Windows Server 2012 R2 |
| Windows 10    |                        |

*Terminalserver / Citrix are not supported.*

Do you like your marking system to print independently of a host system in the stand-alone mode? cablabel® S3 supports again: After having designed the label, the software supplies you with all necessary data stored within the printer for stand-alone mode.

cablabel® S3 is of modular design and can be adapted to your requirements step by step: In order to support functions like native programming with JScript, elements like JScript-Viewer are embedded as plug-in. The designer user interface and JScript code are synchronized in real time. Special functions like Database Connector or bar code tester can be easily integrated.

# Software tools – Monitoring

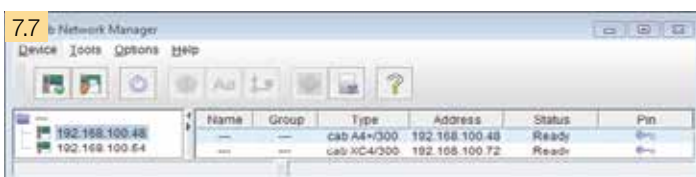

## Administration Network Manager

The cab Network Manager allows the user to simultaneously control a number of printers across a network. It supports from one place monitoring, configuration, firmware updates, memory card administration, file synchronization and PIN administration.



# Printer drivers

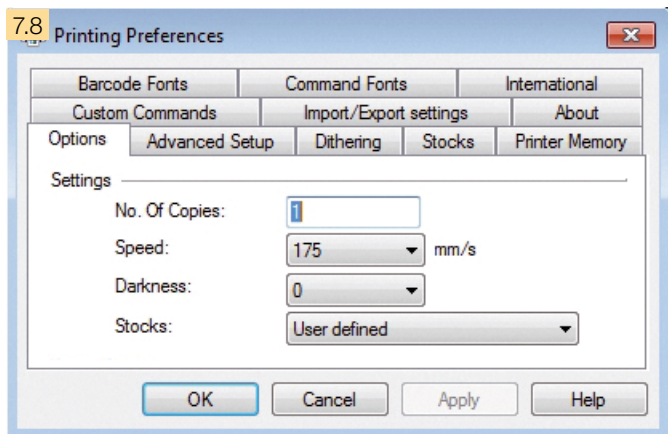

## WHQL certified Windows printer drivers for

Windows Vista	Windows Server 2003
Windows 7	Windows Server 2008
Windows 8	Windows Server 2008 R2
Windows 8.1	Windows Server 2012
Windows 10	Windows Server 2012 R2

Our printer drivers are officially certified and signed by Microsoft. They ensure optimum stability on your Windows operating system. The drivers are included in the scope of delivery.

*Microsoft® is a registered trademark of Microsoft Corporation.*



## Apple-Mac OS X® driver

Alternatively, cab offers a CUPS-based printer driver for programs using Mac OS X. The driver is available as a free download on our website [www.cab.de](http://www.cab.de).

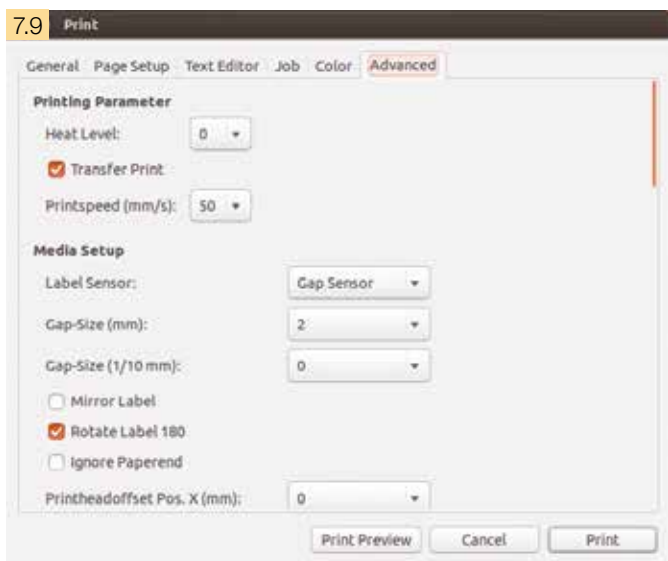

*Mac OS® is a registered trademark of Apple Computer, Inc.*



## Linux driver

Alternatively, cab offers a CUPS-based printer driver for programs using Linux. The driver is available as a free download on our website [www.cab.de](http://www.cab.de).

# Delivery program label printer











	Part No.	Hardware L	Part No.	Spare parts	Part No.	Spare parts	Part No.	Spare parts	
	1.1	<b>5955502</b> <b>5955503</b>	Label printer Hermes+ 2L/300-2 Label printer Hermes+ 2L/600-2	<b>5954105.001</b> <b>5958686.001</b>	Print head 2/300 Print head 2/600	<b>5954102.001</b>	Print roller DR2	<b>5961015.001</b>	Drawing roller ZR2
	1.2	<b>5955504</b> <b>5955505</b> <b>5955506</b>	Label printer Hermes+ 4L/200-2 Label printer Hermes+ 4L/300-2 Label printer Hermes+ 4L/600-2	<b>5954081.001</b> <b>5954072.001</b> <b>5954077.001</b>	Print head 4/200 Print head 4/300 Print head 4/600	<b>5954180.001</b>	Print roller DR4	<b>5961298.001</b>	Drawing roller ZR4
	1.3	<b>5955509</b> <b>5955510</b>	Label printer Hermes+ 6L/200-2 Label printer Hermes+ 6L/300-2	<b>5954217.001</b> <b>5956322.001</b>	Print head 6/200 Print head 6/300	<b>5954245.001</b>	Print roller DR6	<b>5961220.001</b>	Drawing roller ZR6
	1.1	<b>5961410</b> <b>5961411</b>	Label printer Hermes+ 2L/300-3 Label printer Hermes+ 2L/600-3	<b>5954105.001</b> <b>5958686.001</b>	Print head 2/300 Print head 2/600	<b>5954102.001</b>	Print roller DR2	<b>5961015.001</b>	Drawing roller ZR2
	1.2	<b>5955511</b> <b>5955512</b> <b>5955513</b>	Label printer Hermes+ 4L/200-3 Label printer Hermes+ 4L/300-3 Label printer Hermes+ 4L/600-3	<b>5954081.001</b> <b>5954072.001</b> <b>5954077.001</b>	Print head 4/200 Print head 4/300 Print head 4/600	<b>5954180.001</b>	Print roller DR4	<b>5961298.001</b>	Drawing roller ZR4
	1.3	<b>5955516</b> <b>5955517</b>	Label printer Hermes+ 6L/200-3 Label printer Hermes+ 6L/300-3	<b>5954217.001</b> <b>5956322.001</b>	Print head 6/200 Print head 6/300	<b>5954245.001</b>	Print roller DR6	<b>5961220.001</b>	Drawing roller ZR6
	Part No.	Hardware R	Part No.	Spare parts	Part No.	Spare parts	Part No.	Spare parts	
	1.1	<b>5955752</b> <b>5955753</b>	Label printer Hermes+ 2R/300-2 Label printer Hermes+ 2R/600-2	<b>5954105.001</b> <b>5958686.001</b>	Print head 2/300 Print head 2/600	<b>5954102.001</b>	Print roller DR2	<b>5961015.001</b>	Drawing roller ZR2
	1.2	<b>5955754</b> <b>5955755</b> <b>5955756</b>	Label printer Hermes+ 4R/200-2 Label printer Hermes+ 4R/300-2 Label printer Hermes+ 4R/600-2	<b>5954081.001</b> <b>5954072.001</b> <b>5954077.001</b>	Print head 4/200 Print head 4/300 Print head 4/600	<b>5954180.001</b>	Print roller DR4	<b>5961298.001</b>	Drawing roller ZR4
	1.3	<b>5955759</b> <b>5955760</b>	Label printer Hermes+ 6R/200-2 Label printer Hermes+ 6R/300-2	<b>5954217.001</b> <b>5956322.001</b>	Print head 6/200 Print head 6/300	<b>5954245.001</b>	Print roller DR6	<b>5961220.001</b>	Drawing roller ZR6
	1.1	<b>5961412</b> <b>5961413</b>	Label printer Hermes+ 2R/300-3 Label printer Hermes+ 2R/600-3	<b>5954105.001</b> <b>5958686.001</b>	Print head 2/300 Print head 2/600	<b>5954102.001</b>	Print roller DR2	<b>5961015.001</b>	Drawing roller ZR2
	1.2	<b>5955761</b> <b>5955762</b> <b>5955763</b>	Label printer Hermes+ 4R/200-3 Label printer Hermes+ 4R/300-3 Label printer Hermes+ 4R/600-3	<b>5954081.001</b> <b>5954072.001</b> <b>5954077.001</b>	Print head 4/200 Print head 4/300 Print head 4/600	<b>5954180.001</b>	Print roller DR4	<b>5961298.001</b>	Drawing roller ZR4
	1.3	<b>5955766</b> <b>5955767</b>	Label printer Hermes+ 6R/200-3 Label printer Hermes+ 6R/300-3	<b>5954217.001</b> <b>5956322.001</b>	Print head 6/200 Print head 6/300	<b>5954245.001</b>	Print roller DR6	<b>5961220.001</b>	Drawing roller ZR6

Part No.	Hardware options
<b>595xxx.201</b>	Label printer Hermes+ with cover <sup>1)2)</sup>
<b>595xxx.202</b>	Label printer Hermes+ with ribbon saver <sup>3)</sup>
<b>595xxx.203</b>	Label printer Hermes+ with cover <sup>1)2)</sup> and ribbon saver <sup>3)</sup>
<b>on request</b>	Label printer Hermes+ with label roll core diameter of 40 mm only for Hermes+2 and 4 adapter for core diameter 50 mm
<b>5961406</b>	<sup>1)</sup> only for label rolls up to 205 mm Ø <sup>2)</sup> not to be combined with vacuum-belt applicator <sup>3)</sup> only for Hermes+4 and 6
	If the immersion depth of the tamp pad exceeds >25 mm, the cover has to be modified.











Content of delivery:
Label printer, Power cable Type E+F, length 1,8 m, Connecting cable USB, length 1,8 m, Operation manual de/en
<b>DVD:</b> Operation manual de/en/fr, Configuration manual de/en/fr, Service manual de/en, Spare part list de/en, Programmer's guide en, Windows printer driver 32/64 bit in 19 languages for Windows Vista Server 2003 Windows 7 Server 2008 Windows 8 Server 2008 R2 Windows 8.1 Server 2012 Windows 10 Server 2012 R2 Label software cablabel® S3 Lite Label software cablabel® S3 Viewer For current data please surf to <a href="http://www.cab.de">www.cab.de</a>

Type code		
Label printer Hermes+		4L/200-2
Label width	58 mm 114 mm 174 mm	2 4 6
Dispensing to the	left right	L R
Print resolution	203 dpi 300 dpi 600 dpi	200 300 600
for print rolls Ø up to	205 mm 305 mm	2 3

























# Delivery program applicators and transfer modules











		Part No.	Applicators L		Part No.	Transfer modules
5.1		<b>5970075</b>	Swing applicator 3214L-40		xxxxxxx xxxxxxx xxxxxxx xxxxxxx	Tamp pad 3214L-11 F B x H Tamp pad with damping pad 3214L-12 F B x H Tamp pad with label stop 3214L-61 F B x H Blow pad 3214L-2100 B x H
5.2		<b>5966109</b>	Stroke applicator 4114L-200		xxxxxxx xxxxxxx xxxxxxx xxxxxxx xxxxxxx	Tamp pad 4114L-11 F B x H Tamp pad with damping pad 4114L-12 F B x H Tamp pad with label stop 4114L-61 F B x H Blow pad 4114L-2100 B x H Silicon pad 4114L-8800 B x H
		<b>5971795</b> <b>5972016</b> <b>5972017</b>	Stroke applicator 4116L-200 Stroke applicator 4116L-300 Stroke applicator 4116L-400			xxxxxxx xxxxxxx xxxxxxx xxxxxxx
5.3		<b>5966117</b> <b>5966118</b> <b>5966119</b>	Stroke-turn applicator 4214L-200 Stroke-turn applicator 4214L-300 Stroke-turn applicator 4214L-400		xxxxxxx xxxxxxx xxxxxxx xxxxxxx	Tamp pad 4214L-11 F B x H Tamp pad with damping pad 4214L-12 F B x H Tamp pad with label stop 4214L-61 F B x H Blow pad 4214L-2100 B x H
5.4		<b>5966133</b> <b>5966134</b> <b>5966135</b>	Stroke applicator 4414L-200 Stroke applicator 4414L-300 Stroke applicator 4414L-400		xxxxxxx xxxxxxx xxxxxxx	Tamp pad 4414L-11 F B x H Tamp pad with damping pad 4414L-12 F B x H Tamp pad with label stop 4414L-61 F B x H
5.5		<b>5971625</b> <b>5966168</b> <b>5971640</b>	Swing-stroke applicator 4514L-200 Swing-stroke applicator 4514L-300 Swing-stroke applicator 4514L-400		xxxxxxx	Blow pad 4514L-2100 B x H
5.7		<b>5970100</b> <b>5970101</b> <b>5970102</b>	Front-side applicator 3014L-200 Front-side applicator 3014L-300 Front-side applicator 3014L-400		xxxxxxx xxxxxxx xxxxxxx	Tamp pad 3014L -1100 B x H Spring-mounted tamp pad 3014L -3100 B x H Blow pad 3014L -2100 B x H
		<b>5970103</b> <b>5970104</b> <b>5970105</b>	Front-side applicator 3016L-200 Front-side applicator 3016L-300 Front-side applicator 3016L-400		xxxxxxx xxxxxxx	Tamp pad 3016L -1100 B x H Spring-mounted tamp pad 3016L -3100 B x H
5.8		<b>5966101</b> <b>5966102</b> <b>5966103</b>	Stroke applicator 4014L-200 Stroke applicator 4014L-300 Stroke applicator 4014L-400		<b>5966147</b> <b>5966148</b> <b>5966149</b> <b>5966150</b>	Universal pad 4014L-1100 75 x 60 Universal pad 4014L-1100 90 x 90 Spring-mounted universal pad 4014L-3100 116 x 102 Spring-mounted universal pad 4014L-3100 116 x 152
		<b>5966161</b> <b>5966162</b> <b>5966163</b>	Stroke applicator 4016L-200 Stroke applicator 4016L-300 Stroke applicator 4016L-400		xxxxxxx xxxxxxx xxxxxxx xxxxxxx xxxxxxx	Tamp pad 4014L-11 F B x H Blow pad 4014L-2100 B x H Spring-mounted tamp pad 4014L-3100 B x H Roll-on pad 4014L-4100 B x H Corner-wrap pad 4014L-5100 B x H / H
5.9		<b>5971720</b> <b>5971725</b> <b>5971730</b>	Stroke-blow applicator 4614L-200 Stroke-blow applicator 4614L-300 Stroke-blow applicator 4614L-400		xxxxxxx	Blow pad with height sensor 4614L-2100 B x H
5.10		<b>5966144</b>	Demand module 5114L			
5.11		<b>5971650</b>	Vacuum-belt applicator 5314L			
		<b>5971680</b>	Vacuum-belt applicator 5316L			
5.12		<b>5971581</b>	Air-jet-box 6014L		<b>5971581</b> xxxxxxx	Blow module 6014 L/R universal Blow module 6014L B x H configured

# Delivery program applicators and transfer modules

		Part No.	Applicators R		Part No.	Transfer modules
5.1		<b>5971655</b>	Swing applicator 3214R-40		xxxxxxx xxxxxxx xxxxxxx xxxxxxx	Tamp pad 3214R-11 F B x H Tamp pad with damping pad 3214R-12 F B x H Tamp pad with label stop 3214R-61 F B x H Blow pad 3214R-2100 B x H
5.2		<b>5966105</b>	Stroke applicator 4114R-200		xxxxxxx xxxxxxx xxxxxxx xxxxxxx xxxxxxx	Tamp pad 4114R-11 F B x H Tamp pad with damping pad 4114R-12 F B x H Tamp pad with label stop 4114R-61 F B x H Blow pad 4114R-2100 B x H Silicone form pad 4114R-8800 B x H
		<b>5972018</b> <b>5972019</b> <b>5972020</b>	Stroke applicator 4116R-200 Stroke applicator 4116R-300 Stroke applicator 4116L-400			xxxxxxx xxxxxxx xxxxxxx xxxxxxx
5.3		<b>5966121</b> <b>5966122</b> <b>5966123</b>	Stroke-turn applicator 4214R-200 Stroke-turn applicator 4214R-300 Stroke-turn applicator 4214R-400		xxxxxxx xxxxxxx xxxxxxx xxxxxxx	Tamp pad 4214R-11 F B x H Tamp pad with damping pad 4214R-12 F B x H Tamp pad with label stop 4214R-61 F B x H Blow pad 4214R-2100 B x H
5.4		<b>5966137</b> <b>5966138</b> <b>5966139</b>	Stroke applicator 4414R-200 Stroke applicator 4414R-300 Stroke applicator 4414R-400		xxxxxxx xxxxxxx xxxxxxx	Tamp pad 4414R-11 F B x H Tamp pad with damping pad 4414R-12 F B x H Tamp pad with label stop 4414R-61 F B x H
5.5		<b>5966950</b> <b>5971460</b> <b>5971700</b>	Swing-stroke applicator 4514R-200 Swing-stroke applicator 4514R-300 Swing-stroke applicator 4514R-400		xxxxxxx	Blow pad 4514R-2100 B x H
5.7		<b>5970106</b> <b>5970107</b> <b>5970108</b>	Front-side applicator 3014R-200 Front-side applicator 3014R-300 Front-side applicator 3014R-400		xxxxxxx xxxxxxx xxxxxxx	Tamp pad 3014R -1100 B x H Spring-mounted tamp pad 3014R -3100 B x H Blow pad 3014R -2100 B x H
		<b>5970109</b> <b>5970110</b> <b>5970111</b>	Front-side applicator 3016R-200 Front-side applicator 3016R-300 Front-side applicator 3016R-400	xxxxxxx xxxxxxx	Tamp pad 3016R -1100 B x H Spring-mounted tamp pad 3016R -3100 B x H	
5.8		<b>5966140</b> <b>5966141</b> <b>5966142</b> <b>5966143</b>				Universal pad 4014R-1100 75 x 60 Universal pad 4014R-1100 90 x 90 Spring-mounted universal pad 4014R-3100 116 x 102 Spring-mounted universal pad 4014R-3100 116 x 152
		<b>5966105</b> <b>5966106</b> <b>5966107</b> <b>5966165</b> <b>5966166</b> <b>5966167</b>	Stroke applicator 4014R-200 Stroke applicator 4014R-300 Stroke applicator 4014R-400 Stroke applicator 4016R-200 Stroke applicator 4016R-300 Stroke applicator 4016R-400	xxxxxxx xxxxxxx xxxxxxx xxxxxxx xxxxxxx xxxxxxx	Tamp pad 4014R-11 F B x H Blow pad 4014R-2100 B x H Spring-mounted tamp pad 4014R-3100 B x H Roll-on pad 4014R-4100 B x H Corner-wrap pad 4014R-5100 B x H / H	
5.9		<b>5971735</b> <b>5971740</b> <b>5971745</b>	Stroke-blow applicator 4614R-200 Stroke-blow applicator 4614R-300 Stroke-blow applicator 4614R-400		xxxxxxx	Blow pad with height sensor 4614R-2100 B x H
5.10		<b>5966145</b>	Demand module 5114R			
5.11		<b>5971670</b>	Vacuum-belt applicator 5314R			
		<b>5971690</b>	Vacuum-belt applicator 5316R			
5.12		<b>5971577</b>	Air-jet-box 6014R		<b>5971581</b> xxxxxxx	Blow module 6014 L/R universal Blow module 6014R B x H configured

# Delivery program accessories

	Part No.	Extras Hermes+
2.1	 <b>961000.001</b> <b>5961070.001</b> <b>5961193.001</b>	Cover 2L Cover 4L Cover 6L If the immersion depth of the tamp pad exceeds 25 mm, the cover has to be modified.
	 <b>961190.001</b> <b>5961187.001</b> <b>5961196.001</b>	Cover 2R Cover 4R Cover 6R Cover not to be combined with vacuum-belt applicator
2.2	 <b>5954380.001</b>	External operation panel
2.3	 <b>5901630</b>	Standard keyboard USB German version
2.4	 <b>5561043</b>	Memory card CompactFlash Typ I
2.5	 <b>5964300</b>	Product sensor to start 25 pin Connection Hermes+
2.6	 <b>5970071</b>	Product sensor to start 3 pin Connection Air-jet-box
2.7	 <b>5917651</b>	I/O-Interface connector SUB-D-plug 25 pole Phoenix Contact No. 2761622
2.8	 <b>5961237.001</b>	Warning light
2.9	 <b>5918092</b>	Circular connector 3-pin M8
	 <b>5918003</b>	Circular connector 4-pin M8
	Part No.	Interfaces
3.1	 <b>5954200</b>	Centronics interface
3.2	 <b>5954201</b>	RS422/RS485 interface
3.3	 <b>5954191</b>	Label selection - I/O-Box
3.4	 <b>5961349</b>	I/O interface adapter
	Part No.	Connecting cable
4.1	 <b>5550818</b>	Connecting cable RS232 C 9/9-pin, length 3 m
4.2	 <b>5918008</b>	Patch cable KAT 5e, 3 m grey
	Part No.	Extras Applicators
5.13	 <b>5964277.001</b>	Blow tube 2"
	 <b>5964095.001</b>	Blow tube 4"
	 <b>5964614.001</b>	Blow tube 6"
5.14	 <b>5955735</b>	Air pressure regulation unit L
	 <b>5955736</b>	Air pressure regulation unit R
5.15	 <b>5955737</b>	Air pressure regulation unit L with main valve
	 <b>5955738</b>	Air pressure regulation unit R with main valve

	Part No.	Extras Applicators
5.16	 <b>5971556</b>	Air pressure regulation unit L with shut-off valve
	 <b>5971559</b>	Air pressure regulation unit R with shut-off valve
5.17	<b>596xxxx.212</b>	Compressed air regulator valve to reduce tamp force
	Part No.	Mounting aid
6.1	 <b>5965940</b>	Adapter plate
6.2	 on request	Profile
6.3	 <b>5961203</b>	Base plate 500 x 255 mm
6.4	 <b>5958400</b>	Mounting plate
6.5	 <b>5955685</b>	Bracket
6.6	 <b>8914443</b>	Clamped joint for profile 50 x 50 mm
6.7	 <b>8914444</b>	Flanged joint for profile 50 x 50 mm
6.8	 <b>5970113</b>	Stand 1601
6.9	 <b>5970112</b>	Stand 1602
	Part No.	Software
7.6	<b>5588000</b>	Label software cablabel® S3 Lite
	<b>5588001</b>	cablabel® S3 Pro 1 WS
	<b>5588100</b>	cablabel® S3 Pro 5 WS
	<b>5588101</b>	cablabel® S3 Pro 10 WS
	<b>5588150</b>	cablabel® S3 Pro 1 additional licence
	<b>5588151</b>	cablabel® S3 Pro 4 additional licences
	<b>5588152</b>	cablabel® S3 Pro 9 additional licences
	<b>5588002</b>	cablabel® S3 Print 1 WS
	<b>5588105</b>	cablabel® S3 Print 5 WS
	<b>5588106</b>	cablabel® S3 Print 10 WS
<b>5588155</b>	cablabel® S3 Print 1 additional licence	
<b>5588156</b>	cablabel® S3 Print 4 additional licences	
<b>5588157</b>	cablabel® S3 Print 9 additional licences	
	In preparation	cablabel® S3 Print Server
7.10	<b>9008486</b>	Programmer's guide English, printed copy



# cab product range at a glance

**Label printer EOS1**  
The compact one for  
label rolls up to 155 mm diameter



**Label printer EOS4**  
The cost-effective one for  
label rolls up to 210 mm diameter



**Label printer EOS mobile**  
Both EOS sizes with  
battery pack for mobile print



**Label printers A+ series**  
The universal ones



**Label printer A4+M**  
With centered material positioning



**Label printer A4+T**  
With centered material positioning  
also for textile materials



**Label printer XD4T**  
Double-sided printing



**Label printers XC series**  
Two-color printing



**Label dispensers HS/VS**  
Precise horizontal or vertical  
dispensing up to 180 mm width



**Print & apply system Hermes+**  
For automation



**Print & apply system Hermes C**  
For two-color printing and applying



**Print modules PX series**  
For integration into  
automatic labeling systems



**Consumables**  
Precise printing with cab labels  
and ribbons



**Label software cablabel S3**  
Standard and optional



**Laser marking system FL+ series**  
Precise and fast



**Laser safety housing**  
The industrial solution



 Headquarter and fabrication in Germany

 to  International subsidiaries

There are furthermore 820 distribution partners in more than 80 countries.



## Europe

### Germany

cab Produkttechnik GmbH & Co KG  
Wilhelm-Schickard-Str. 14  
76131 Karlsruhe  
phone +49 721 6626 0  
fax +49 721 6626 129  
[info@cab.de](mailto:info@cab.de)  
[www.cab.de](http://www.cab.de)

cab Produkttechnik Sömmerda GmbH  
Am Unterwege 18-20  
99610 Sömmerda  
phone +49 3634 6860 0  
fax +49 3634 6860 129  
[info@cab.de](mailto:info@cab.de)  
[www.cab.de](http://www.cab.de)

### France

cab Technologies S.à.r.l.  
2a Rue de la Moder  
Z.A. Nord du Val de Moder  
67350 Niedermodern  
phone +33 388 722501  
fax +33 388 722502  
[info.fr@cab.de](mailto:info.fr@cab.de)  
[www.cab.de/fr](http://www.cab.de/fr)

## America

### USA

cab Technology, Inc.  
87 Progress Avenue Unit 1  
Tyngsboro, MA 01879  
phone +1 978 649 0293  
fax +1 978 649 0294  
[info.us@cab.de](mailto:info.us@cab.de)  
[www.cab.de/us](http://www.cab.de/us)

### Latin America

Alejandro Balmaceda  
Hacienda Jurica Pte 1615  
Colonial de Valle  
32553 Ciudad Juárez  
phone +52 656 682 3745  
fax +52 656 682 4301  
[a.balmaceda@cab.de](mailto:a.balmaceda@cab.de)  
[www.cab.de/es](http://www.cab.de/es)

## Asia

### Taiwan

cab Technology Co., Ltd.  
希愛比科技股份有限公司  
16F-1, No. 700, Jhong Jheng Rd  
Junghe, Taipei 23552  
phone +886 (02) 8227 3966  
fax +886 (02) 8227 3566  
[info.asia@cab.de](mailto:info.asia@cab.de)  
[www.cab.de/tw](http://www.cab.de/tw)

### China

cab (Shanghai) Trading Co., Ltd.  
铠博(上海)贸易有限公司  
A507, No. 268, Tong Xie Rd  
Shanghai 200335  
phone +86 (021) 6236 3161  
fax +86 (021) 6236 3162  
[info.cn@cab.de](mailto:info.cn@cab.de)  
[www.cab.de/cn](http://www.cab.de/cn)

cab (Shanghai) Trading Co., Ltd.  
铠博(上海)贸易有限公司  
Room 39, 10F, 8 Lin He Zhong Rd  
Tian He District, Guangzhou 510610  
phone +86 (020) 2831 7358  
[info.cn@cab.de](mailto:info.cn@cab.de)  
[www.cab.de/cn](http://www.cab.de/cn)

## Africa

### South Africa

cab Technology (Pty) Ltd.  
14 Republic Street  
Bordeaux  
2125 Randburg  
phone +27 11 886 3580  
fax +27 11 789 3913  
[info.za@cab.de](mailto:info.za@cab.de)  
[www.cab.de/za](http://www.cab.de/za)