

G E R M A N
P A C K A G I N G
A W A R D 2 0 1 5

Two-Color Print and Apply System Hermes C

Made in Germany

Two-color printing and applying in real-time

Hermes C is the first labeling system worldwide to print and apply two-color labels in one operation. It has been developed and optimized especially for applications corresponding to the new Classification and Labeling Inventory according to GHS.

Due to the integrated backfeed system single labels can be printed and applied on request without loss of labels.

All shapes of packaging can be marked, for example bottles, cans, drums, buckets, cardboard or pallets.

Because of the modular construction system Hermes C offers a proper solution for every application.



- **Designed for industrial application**
- **Simple integration in production lines**
- **Interfaces to connect to ERP and Process Control Systems are available**

When it comes to marking chemicals and hazardous substances, GHS and REACH demand new, standardized pictograms. The guidelines apply worldwide.

As part of this standardization, imperfectly printed danger symbols, for example blank rhombs, are not permitted any longer.

With Hermes C labels can be individually designed and printed.

For your application we provide labels and ribbons, BS5609/3 certified as well (see page 11).

Sample label

GLUTARALDEHYDE SOLUTION 50%

23005 QTY NET 1 KG 0,88 L. BATCH: test281114

UN 3265
CLASS 8 E2

CORROSIVE LIQUID, ACIDIC, ORGANIC,
N.O.S., Glutaraldehyde
CAS: 111-30-8

DANGER **Hazardous Statements** Very toxic to aquatic life. May cause respiratory irritation. May cause allergy or asthma symptoms or breathing difficulties if inhaled. May cause an allergic skin reaction. Causes severe skin burns and eye damage. Toxic if swallowed or if inhaled. Harmful to aquatic life with long lasting effects. **Precautionary Statements** Avoid breathing dust / fume / gas / mist / vapors / spray. Wear protective gloves / protective clothing / eye protection / face protection. In case of inadequate ventilation wear respiratory protection. IF SWALLOWED: immediately call a POISON CENTER or doctor / physician. IF ON SKIN (or hair): remove / take off immediately all contaminated clothing. Rinse skin with water / shower. IF IN EYES: rinse cautiously with water for several minutes. Remove contact lenses, if present and easy to do. Continue rinsing. Immediately call a POISON CENTER or doctor / physician. If experiencing respiratory symptoms: call a POISON CENTER or doctor / physician. Store in a well-ventilated place. Keep container tightly closed. Contains 1,5-pentanedial

cab Produkttechnik GmbH & Co KG · Wilhelm-Schickard-Str. 14 · 76131 Karlsruhe / Germany · Emergency number +49 721 6626-0

All information on scopes of delivery, design and technical specifications correspond to the date of the printing. Subject to change. For current data see website www.cab.de/en/hermes-c.

Technical details

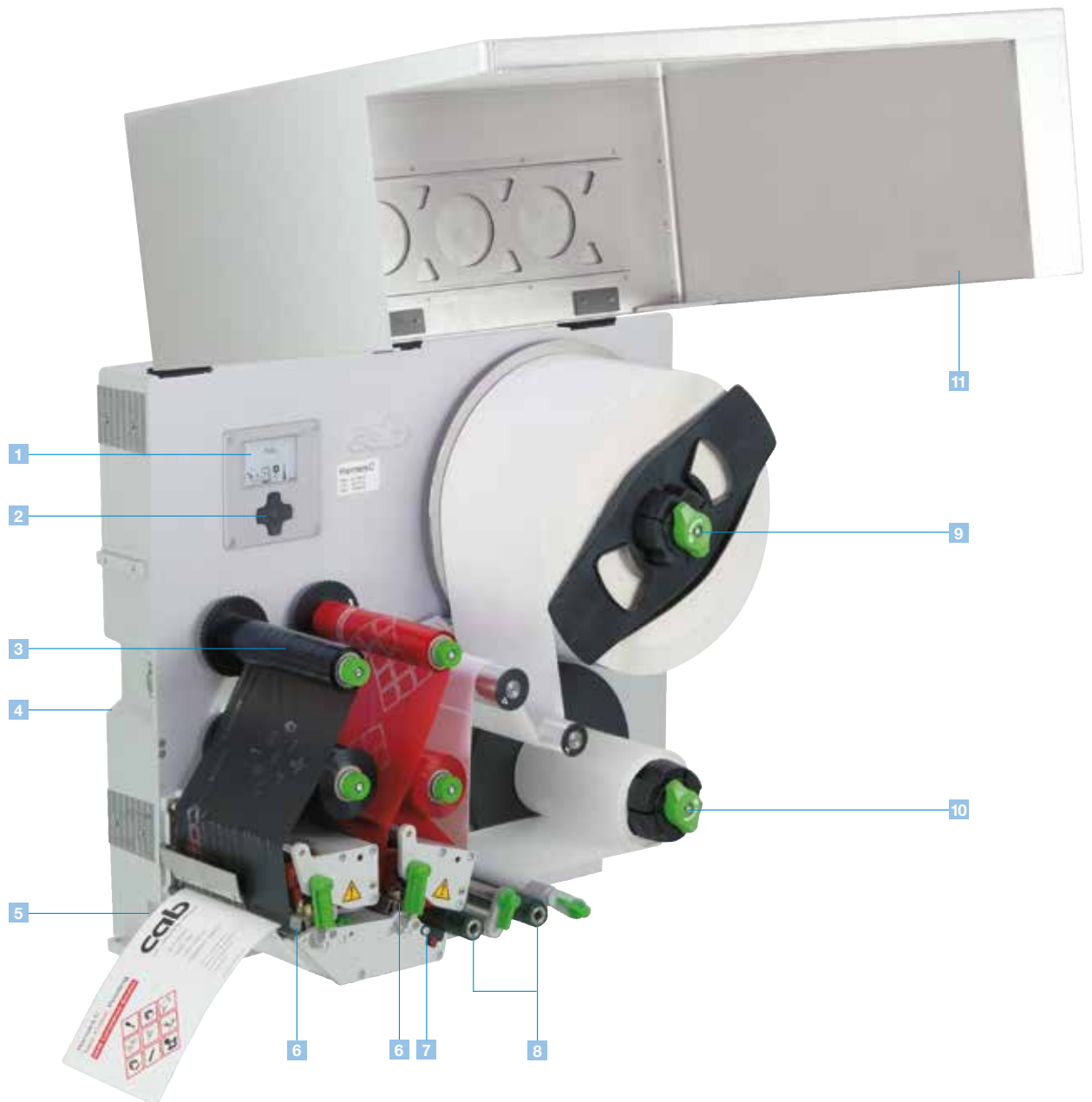

1 Graphic display

The white backlight provides good readability. Depending on the installation position, the display may be turned in 90° steps.

2 Navigator pad

Simple, interactive menu control, only applicable functions are displayed by the day and night design. Along with the graphic display the menu navigation is easy to understand.

3 Ribbon holder

Quick and simple exchange of ribbon due to three-part tightening axles

4 Metal chassis

For the mounting of the modules it is made of torsion resistant die-cast aluminum.

5 Print positioning

The print position is automatically set after a new label roll has been inserted. The reference value is kept even if the device is switched off.

6 Print heads 1 and 2

The pressing force can be adjusted according to the label width.

7 Ribbon saver

At print head 1 the print head is lifted within the unprinted area and the ribbon is stopped during label feeding.

8 Transport system

Ball bearing mounted rollers provide high printing accuracy.

9 Label unwinder

Due to the swing lever and an integrated brake the labels are unwound with constant tension.

10 Liner rewinder

The liner of a label roll is completely rewound after the labels have been peeled off. The steering axle enables an easy exchange of the label roll.

11 Cover

To protect from dust and damage a cover can be mounted.

Required interfaces

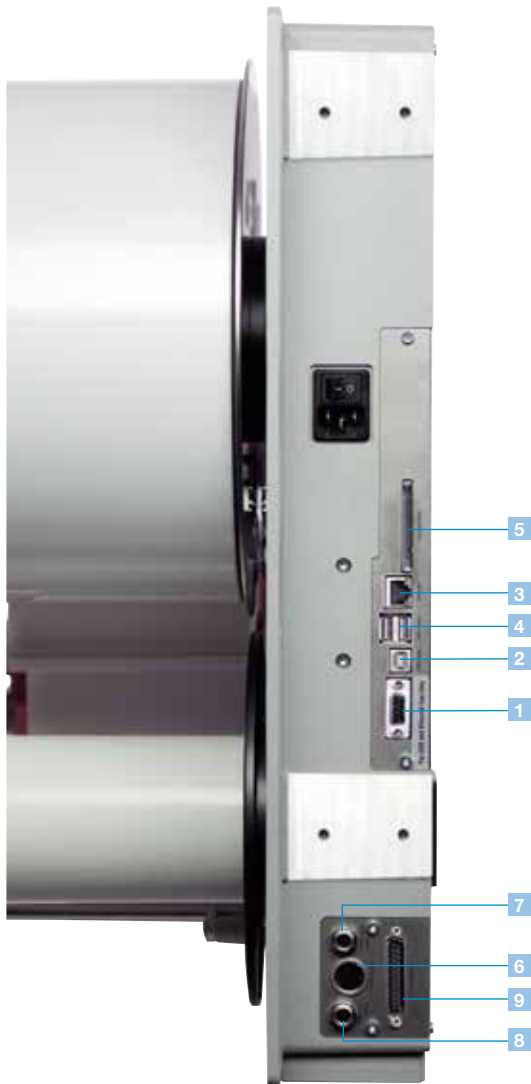

- 1 RS232C interface (restricted function)
- 2 USB 2.0 slave interface
- 3 Ethernet 10/100 Base-T interface with TCP/IP
- 4 Two USB master interfaces to connect an external operation panel, a keyboard, a scanner or a service key
- 5 Slot for a CompactFlash Type I memory card
- 6 Connection of a warning light:
The warning light displays the printer status.
Green Device switched on
Yellow Prewarning to end of label resp. ribbon
Red Error
- 7 Connection of a main valve for air pressure supply:
For centrally switching on or off the compressed air supply
- 8 Connection of an external E-Stop:
Along with a connected main valve this interface allows to interrupt compressed air supply in case of emergency.
- 9 Digital I/O interface:
25-pin Sub-D connector,
IEC 61131-2 type 3 compliant for inputs and outputs,
protected against reverse polarity, ESD up to 8 kV,
outputs current limited and short-circuit proof

Inputs

- Start printing and applying
- Reprint
- Label feed
- Delete print job
- Pause
- Label dispensed
- Reset
- Stop printing and applying
- Print first label

Outputs

- Ready to operate
- Print data available
- Paper feed on
- Prewarning end of ribbon
- Prewarning end of label
- Error end of ribbon
- Error end of label
- Label in dispensing position
- Basic position/upper end position
- Applying position/lower end position
- Common alarm

Technical data

		1.1
Label printer		Hermes C 6L/300-3
Print head		
Method of printing		Thermal transfer
Printable resolution	dpi	300
Print speed	up to mm/s	125
Print width	up to mm	162.6
Material		
Labels on rolls	Paper, plastics such as PET, PE, PP, PVC, PU, acrylate, PI	
Thickness mm/weight g/m ²	0.05-0.2/60-160	
Width labels ¹⁾	mm	46-176
liner	mm	50-180
Label height	mm	20-356
Media roll	outer diameter	up to mm
	core diameter	mm
	winding	Outside or inside
Ribbon		
Ink		Outside or inside
Roll diameter	up to mm	80
Core diameter	mm	25
Ribbon length	up to m	450
Width ²⁾	up to mm	165
Ribbon saver print head 1		■
Internal rewinder		
Outer diameter	up to mm	210
Core diameter	mm	76
Dimensions and weight		
Height x depth x width		mm 550 x 630 x 320
Weight		approx. kg 30
Label sensor		
Gap sensor	For leading edge of label and end of material	
Distance to locating edge	mm	4-47
Electronics		
Processor 32 bit clock rate	MHz	266
Main storage (RAM)	MB	64
IFFS printer memory	MB Flash	8
Slot for CompactFlash Type I		■
Battery buffer for real-time clock with printout of time and date/data storage when power off		■
Warning in case of error		■
Interfaces		
RS232C 1,200 to 230,400 baud/8 bit		■
USB 2.0 highspeed slave for PC		■
Ethernet 10/100 Base-T, LPD, RawIP printing, ftp printing, DHCP, HTTP, FTP, SMTP, SNMP, TIME, zeroconf, mDNS, SOAP		■
2x USB master for external operation panel, keyboard, scanner, service key		■
Warning light		■
Digital I/O		■
Connection of applicator		■
External E-Stop		■
Main valve for air pressure supply		■
Operating data		
Power supply		100-240 VAC ~ 50/60 Hz, PFC
Power consumption		up to W 300
Temperature/operation:	5-40 °C/10-85 % not condensing	
air humidity stock:	0-60 °C/20-80 % not condensing	
transport:	-25-60 °C/20-80 % not condensing	
Approvals	CE, FCC class A, CB, CCC, UL	
Operation panel		
Push buttons/LED	Pause, feed, cancel, menu, enter, 4 x cursor	
LCD graphic display	Width 60 mm, height 40 mm, four lines of text	
Settings		
Time, date, digital or analog clock, language settings, device settings, print parameters, interfaces, security		
On display		
Data reception	Temperature print head	abc debug
Ethernet status	Memory card access	Input buffer
Use memory	Clock/date sheet	Ribbon remaining

■ Standard □ Optionally

Monitoring	
Stop print job	If end of ribbon, end of labels, print head open
Prewarning	If end of ribbon, end of labels
Test routines	
System diagnosis	When switched on, including print head testing
Short status, status print	Fonts list, device list, WLAN status, label profile, test grid, monitor mode, PPP status
Status reports	Printout on device settings, e.g. print length counter, runtime counter, request of status via software command, status messages on display, e.g. network error – no link, barcode error, etc.
Fonts	
Font types	5 bitmap fonts including OCR-A, OCR-B and 3 vector fonts Swiss 721, Swiss 721 bold and monospace 821 internally available, TrueType fonts loadable. Optionally: Chinese (simplified), Thai
Character sets	Windows 1250 to 1257, DOS 437, 737, 775, 850, 852, 857, 862, 864, 866, 869, EBC DIC 500, ISO 8859-1 to -10 and -13 to -16, WinOEM 720, UTF-8, Macintosh Roman, DEC MCS, KOI8-R. All Western and Eastern European, Latin, Cyrillic, Greek, Hebrew and Arabic characters are supported. Optionally: Chinese (simplified), Thai
Bitmap fonts	Size of width and height 1-3 mm, zoom factors 2-10, orientation 0°, 90°, 180°, 270°
TrueType fonts	Size of width and height 0,9-128 mm, variable zoom, orientation 360° in steps of 1°
Font formats	Bold, italic, underlined, outline, inverse, depending on character fonts
Font width	Variable
Graphics	
Graphic elements	Lines, arrows, boxes, circles, ellipses, filled and filled with fading
Graphic formats	PCX, IMG, BMP, TIF, MAC, GIF, PNG
Barcodes	
Linear barcodes	Code 39, Code 93 Code 39 Full ASCII Code 128 A, B, C EAN 8, 13 EAN/UCC 128 EAN/UPC Appendix 2 EAN/UPC Appendix 5 FIM HIBC Interleaved 2/5 Ident- and lead code of Deutsche Post Codabar JAN 8, 13 MSI Plessey Postnet RSS 14 UPC A, E, E0
2D codes	Aztec, Codablock F, Data Matrix, PDF 417, Micro PDF 417, UPS Maxicode, QR code, RSS 14 truncated, limited, stacked and stacked omnidirectional, EAN Data Matrix, GS1 Data Bar All Codes are variable in height, module width and ratio. Orientation 0°, 90°, 180°, 270°. Optionally with check digit, printed characters and start/stop code, depending on type of code
Software	
Programming	JScript direct programming abc Basic Compiler Database Connector ■ ■ ■
Monitoring/administration	Printer monitoring Administration Network Manager ■ ■
Label software	cablabel S3 Lite cablabel S3 Viewer cablabel S3 Pro cablabel S3 Print ■ ■ □ □
Windows drivers certified	32/64 bit for Windows Vista Windows 7 Windows 8 Windows 8.1 Windows 10 Server 2003 Server 2008 Server 2008 R2 Server 2012 Server 2012 R2 ■
Stand-alone operation	■

¹⁾ The label size also depends on the type of applicator.

Limitations may apply to small labels, thin materials or strong adhesives. Critical applications need to be tested and approved.

²⁾ Ribbon according to label width in order to avoid folding.

Stroke applicators 4126/4136

2.1

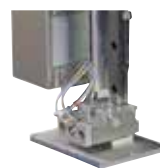

Tamp pad

Labels are precisely applied on flat surfaces.



Spring-mounted tamp pad

Allows labels to be applied even on curved surfaces up to approx. 8°.



Roll-on pad

While in transport, labels are rolled on flat surfaces.

Stroke applicator

For real-time labeling on packaging or products. According to the type of pad the product is either in motion or not. Labels may be applied on the product from all sides.

The pad is positioned above the peel-off plate. The label is held by the applicator during the printing process. A short stroke cylinder turns the tamp pad horizontally to the labeling position and places the label on the product. The cylinder stroke defines the maximum distance from the peel-off plate to the product.

Silicone form pad on request

Stroke applicator		4126L-300	4126L-400	4136L-300	4136L-400
Cylinder stroke	mm	300	400	300	400
Product height		Variable	Variable	Variable	Variable
Horizontal stroke cylinder	mm	25	25	25	25
Labeling on the product		From top, from below, from the side	From top, from below, from the side	From top, from below, from the side	From top, from below, from the side
Air pressure supply	bar	4.5	4.5	4.5	4.5
Blow tube	quantity	1	1	2	2
Cycle time	approx. labels/min. ¹⁾	20	20	20	20
Tamp pad		4126L-11 F	4126L-12 F	4126L-19 F	–
Label width	mm		46-174		–
Label height	mm		20-100		–
Distance product/lower edge of device up to	mm	220		320	–
Immersion depth of pad F ²⁾	up to mm		50		–
Product during labeling			Not moving		–
Spring-mounted tamp pad		4126L-3900		4136L-3900	
Label width	mm		80-174		80-174
Label height ³⁾	mm		80-150		151-356
Distance product/lower edge of device up to	mm	215		315	215 315
Product during labeling			Not moving		Not moving
Roll-on pad		4126L-4900		4136L-4900	
Label width	mm		50-174		50-174
Label height ³⁾	mm		80-150		151-356
Distance product/lower edge of device up to	mm	245-275		345-375	275-360 375-460
Product during labeling			In motion		In motion

¹⁾ Calculated at 100 mm label height and 125 mm/s print speed

²⁾ If the immersion depth of the applicator is > 25 mm, the cover of Hermes C has to be modified.

³⁾ Label roll 210 mm and more preferably inside wound

Vacuum belt applicators 5326/5426

2.2



Vacuum belt applicator

For real-time labeling on packaging or products in motion. Labels may be applied on the product from all sides on a flat surface, on a cylinder resp. by corner wrap labeling.

The vacuum belt applicator is positioned in front of the peel-off plate. The printed label is moved to the labeling position via vacuum belt and applied on the packaging via external signal. Printing and labeling may be done simultaneously.

Vacuum belt applicator		5326L	5426L ¹⁾
Labeling		On the surface	On a cylinder and corner wrap labeling
Label width	mm	46-174	46-174
Label height	mm	80-356	80-356
Product during labeling		In motion	In motion
Labeling on the product		From top, from below, from the side	From top, from below, from the side
Vacuum belt speed	mm/s	100-300	100-300
Cycle time	approx. labels/min. ²⁾	30	30









¹⁾ Available from March 2016









²⁾ Calculated at 100 mm label height and 125 mm/s print speed



**Sample application:
Drum labeling with the
vacuum belt applicator 5426L**

Accessories

Extra equipment Hermes C	Product
3.1 	Cover V for vertical mounting The cover protects the Hermes C from dirt and damage.
3.1 	Cover H for horizontal mounting With additional dust protection at the side of the product
3.2 	External operation panel If the operation panel is not accessible after the printer has been installed, an external operation panel may be additionally connected. There is a slot for a CompactFlash Type I memory card and a USB host interface, which is further available.
3.3 	Standard keyboard USB connection, 115 keys
3.4 	Memory card CompactFlash Type I to store label formats, fonts, texts. Graphics are readable and writable either at the printer or the PC.
3.5 	Product sensor 25-pin To be connected at the Hermes C. Start of printing and applying when a product is detected, e.g. on a conveyor belt.
3.6 	Interface connector Screw terminals enable all control signals to be connected at the Hermes C I/O interface.
3.7 	Warning light The warning light in addition to the display indicates the printer status. Red Error Yellow Prewarning to end of label resp. ribbon Green Device switched on To be mounted directly at the printer or bracket or anywhere else in the surrounding area. Length of connecting cable 1 m

Interface	Product
4.1 	Label selection – I/O box Via a superordinate control, e.g. PLC, up to 16 different labels can be selected from the memory card.
Connecting cable	Product
5.1 	Connecting cable RS232C 9/9-pin, length 3 m
Extra equipment Applicators	Product
6.1 	Blow tube 4"
6.1 	Blow tube 6"
6.2 	Air pressure regulation unit To be directly mounted at Hermes C or the bracket with an angle. Presetting at 4,5 bar
6.3 	Air pressure regulation unit with additional main valve In case of integrating the print and apply system in a production line, air pressure for the applicator can be switched on or off externally. Presetting at 4,5 bar. Only in combination with an E-Stop
6.4 	Circular connector 3-pin M8 for main valve for air pressure supply
6.4 	Circular connector 4-pin M8 for E-Stop
6.5 	Pressure relief valve To reduce the tamp force; to be installed in the applicator

Accessories



Dispensing and removing labels manually

To dispense and remove labels manually a present sensor is needed. In this case, it is advisable to use a mounting foot. The label printer may be mounted with or without a cover.

1 Present sensor PS11

1. Automatic dispensing

The present sensor PS11 detects when the label is in labeling position. After the label has been removed manually the next label is printed instantly.

2. Dispensing on request

The print and apply process can be started by pushing the button at the present sensor

2 Hand switch TR2

Printing and dispensing on request via the I/O interface. The hand switch is connected via a cable.



Mounting foot

To fasten the label printer

1 Adapter plate

The label printer is mounted on the adapter plate. It may also be mounted directly at the production line by means of the adapter plate and the profile.

2 Profile

Standard length 120 mm; further lengths on request



Bracket

With the bracket the Hermes C can be mounted on a stand or in a production line in any position.



Clamped joint for profile 50 x 50 mm

With this clamped joint the labeling system can be moved horizontally and vertically.



Clamped joint for diameter 50 mm

With this clamped joint the labeling system can be moved horizontally and rotated around an axis with a diameter of 50 mm.

Stands for mounting

7.4

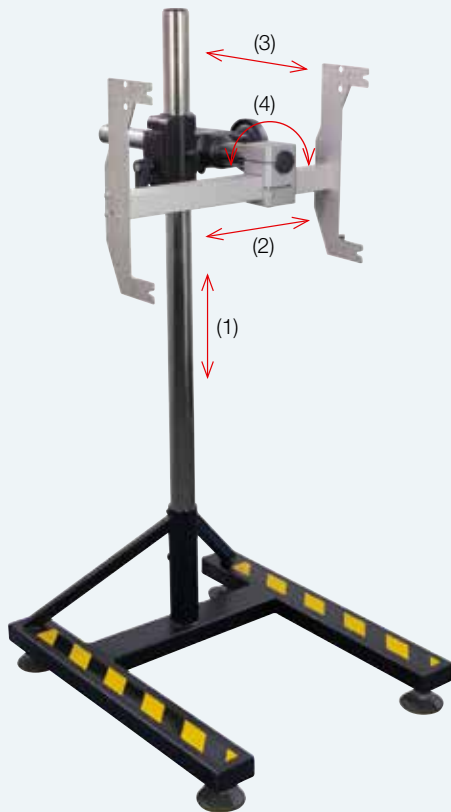

Stand 1622

For mounting Hermes C in a vertical position into a production line. Height and depth are adjustable by a toothed rack/crank. In addition, the labeling system may be rotated 360° around its axis.

The air pressure regulation unit and the warning light are to be mounted on the bracket.

Technical data		Stand 1622
Adjustable feet	mm	± 15
Load	max. kg	75
(1) Lower edge of printer - ground	mm	150-1,100
(2) Depth crosswise to direction of transport	mm	120
(3) Depth lengthwise to direction of transport	mm	100
(4) Rotation	°	± 90
Weight	approx. kg	40



7.5

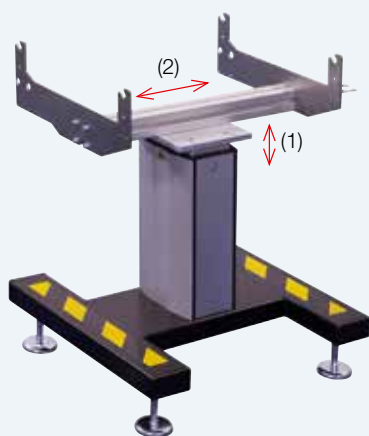

Stand 1221

For mounting Hermes C in a horizontal position into a production line. Height is adjustable by an internal spindle.

The air pressure regulation unit and the warning light are to be mounted on the bracket.

Technical data		Stand 1221
Adjustable feet	mm	± 15
Load	max. kg	75
(1) Lower edge of label - ground ¹⁾	mm	720-960
(2) Depth lengthwise to direction of transport	mm	± 180
Weight	approx. kg	40

¹⁾ Further dimensions on request



Labels and ribbons

- **Two-color** printing on labels in real-time
- For chemical products such as oils, colors or detergents
- On drums, buckets, boxes, pallets etc., resistant to acid and saltwater
- Labels for two-color printing according to GHS
- Certified according to British Maritime Standard BS5609, part 3

Polyester and Polypropylene labels in white matt or glossy are, along with the ribbons R71 black and CR74 red, certified according to the Laboratory Performance of Printed Labels.

In this test labels that have spent at least three months in sea water must stay affixed and still be readable on an aluminum drum.



Labels

Labels in all sizes, with widths 46 to 176 mm and heights 20 to 356 mm, can be manufactured for Hermes C.

Labels						
Material	Width mm	Height mm	Roll Ø max. mm	Labels on roll	Running meter m	Part no.
Paper white, 80 g	102	50	305	6,000	427	5780067
	100	150	305	3,000	458	5780058
	148	210	305	2,000	432	5780059
Polyester white matt, 50 µ	102	50	305	8,000	426	5780065
	100	150	305	3,000	458	5780060
	148	210	305	2,000	432	5780061
Polypropylene white matt, 50 µ	102	50	305	8,000	426	5780066
	100	150	305	3,000	458	5780062
	148	210	305	2,000	432	5780063

Polyester and Polypropylene white glossy on request

Sample label

GLUTARALDEHYDE SOLUTION 50%

23005 QTY NET 1 KG
0,88 L. BATCH: test281114

UN 3265

CLASS 8 E2

CORROSIVE LIQUID, ACIDIC, ORGANIC, N.O.S., Glutaraldehyde
CAS: 111-30-8

DANGER Hazardous Statements Very toxic to aquatic life. May cause respiratory irritation. May cause allergy or asthma symptoms or breathing difficulties if inhaled. May cause an allergic skin reaction. Causes severe skin burns and eye damage. Toxic if swallowed or if inhaled. Harmful to aquatic life with long lasting effects. **Precautionary Statements** Avoid breathing dust / fume / gas / mist / vapors / spray. Wear protective gloves / protective clothing / eye protection / face protection. In case of inadequate ventilation wear respiratory protection. IF SWALLOWED: immediately call a POISON CENTER or doctor / physician. IF ON SKIN (or hair): remove / take off immediately all contaminated clothing. Rinse skin with water / shower. IF IN EYES: rinse cautiously with water for several minutes. Remove contact lenses, if present and easy to do. Continue rinsing. Immediately call a POISON CENTER or doctor / physician. If experiencing respiratory symptoms: call a POISON CENTER or doctor / physician. Store in a well-ventilated place. Keep container tightly closed. Contains 1,5-pentanedial

cab Produkttechnik GmbH & Co KG · Wilhelm-Schickard-Str. 14 · 76131 Karlsruhe / Germany · Emergency number +49 721 6626-0



Ribbons

The ribbons are harmonized with Hermes C and the label materials and offer an excellent print quality from the beginning of the roll to the end.

The resin ribbons are resistant to dissolvers and heat and offer high abrasion and scratch resistance.

Ribbons inside wound				
Type		Width mm	Length m	Part no.
Wax/Resin	RW63 black	110	450	5556966
		165	450	5556967
	CRW63 red similar to PMS ¹⁾ 1788C	110	300	5556278 ²⁾
		165	300	5556789 ²⁾
Resin	R71 black	110	450	5556968
		165	450	5556969
	CR74 red similar to PMS ¹⁾ 192C	110	300	5556189 ²⁾
		165	300	5556791 ²⁾

¹⁾ Pantone Matching System

²⁾ Length 450 m available on request

Software features of the label printer

J	Job start
H 100	Speed (100 mm/s)
O R	Orientation rotated by 180°
S I1;0,0,68,70,100	Size label (100x68 mm, gap 2 mm)
T 10, 10,0,5,pt20;sample	Text object/font: Swiss bold, 20 pt
B 10,20,0,EAN-13,SC2,401234512345	Barcode EAN 13, size SC 2
G 8,3.5,0;R:30,9,0,3;0,3	Graphic, box 30x9 mm,
A 1	Line weight 0.3 mm
	Number of labels (in this example 1)

Direct programming with JScript

Every cab printer can be directly programmed with the JScript programming language. JScript is described in the programming manual. The label software cablabel S3 optimally supports the direct programming, but may also be generated with any text editor.

SAP® Member Silver Printer Vendor Program

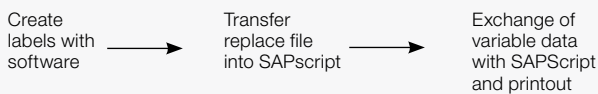

Replace files and integration in SAP R/3*)

In cooperation with SAP cab developed the so-called replace method to control cab printers quickly and easily from SAPscript using SAP R/3. Using this method the host computer only sends the JScript variable, respectively changed data to the printer. As a Silver Level partner in SAP's Printer Vendor Program, cab has access to SAP development environments for optimum printer support.

```

abc - Notepad
File Edit Format View Help
<ABC>
label start
input a$
if left$(a$,15)="194300301480070" then
  print "R t2;";mid$(a$,16)
endif
if left$(a$,15)="194300300580172" then
  print "R t3;";mid$(a$,16)
endif
if left$(a$,15)="194300301970073" then
  print "R t1;";mid$(a$,16)
endif
if a$0"q0001" then
  print "A 1"
endif
goto start
  
```

abc Basic Compiler

As an integrated element of the firmware, the abc Basic Compiler enables the printer to process data via Basic programming before it is sent for print editing. That way, you replace external printer languages or integrate data from other systems, e.g. a scale or PLC.



Printer monitoring with Intra- and Internet

Using standard programs such as the web browser or ftp clients, the integrated HTTP and ftp servers enable printer monitoring and configuration, firmware updates and memory card administration. Status, warning and error messages are sent to administrators or users via e-mails or SNMP datagrams via SNMP and SMTP clients. A time server is used to synchronize time and date.

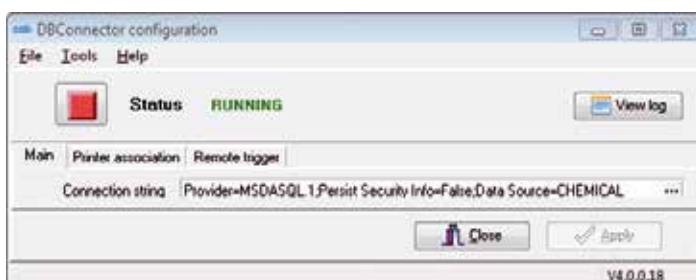

Database Connector

In stand-alone operation with additional network connection this program allows the printer to access data directly from a central ODBC or OLEDB compatible database and print it on a label. At the same time, data can be written back to the database during the printing process. Integrating the Database Connector in cablabel S3 allows to conveniently establish this database connection when designing a layout.

*) SAP and all SAP logos are trademarks or registered trademarks of SAP SE in Germany and in several other countries.

Software tools – label software

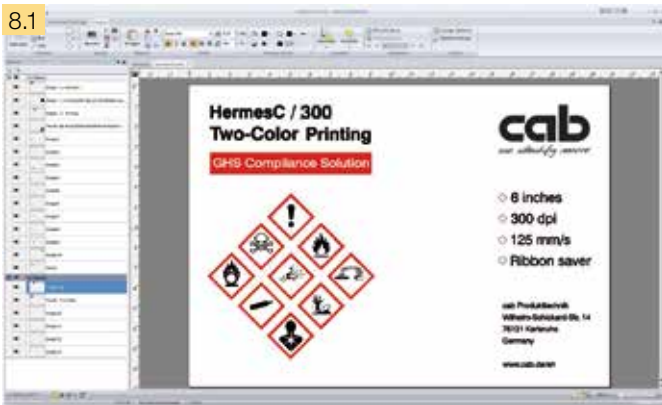

cablabel S3 is a label software that supports two-color applications. Three functions are integrated:

- **Designing**
- **Printing**
- **Monitoring**

cablabel S3 does open up the full potential of cab devices in the design of your label. An extensive instruction set is available within the intuitive user interface, e.g. different date formats, mathematic or logic functions.

In doing so, cablabel S3 brings together all cab marking systems. First of all you design the label. You do not have to decide before printing whether you like the label to be dispensed on a label printer, a print and apply system or a laser marking system.

Do you like your marking system to print independently of a host system in stand-alone operation? cablabel S3 supports again: After having designed the label, the software supplies with all necessary data stored within the printer to be used in stand-alone operation.

cablabel S3 is of modular design and can be adapted to your requirements step by step: In order to support functions like native programming with JScript, elements like JScript viewer are embedded as plugin. The designer user interface and JScript code are synchronized in real-time. Special functions like Database Connector or barcode testers can be easily integrated.

cablabel S3 is available for the following Microsoft*) operating systems in 32 bit and 64 bit versions:

Windows Vista	Windows Server 2008
Windows 7	Windows Server 2008 R2
Windows 8	Windows Server 2012
Windows 8.1	Windows Server 2012 R2
Windows 10	

Terminal servers/Citrix are not supported.

Software tools – monitoring



Administration Network Manager

To simultaneously control a number of printers across a network. It supports monitoring, configuration, firmware updates, memory card administration, file synchronization and PIN administration from one place.

Printer drivers

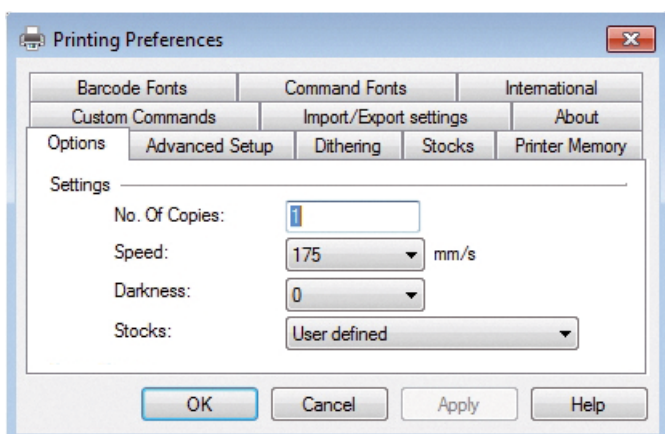





















WHQL certified Windows printer drivers for

Windows Vista	Windows Server 2003
Windows 7	Windows Server 2008
Windows 8	Windows Server 2008 R2
Windows 8.1	Windows Server 2012
Windows 10	Windows Server 2012 R2

















Our printer drivers are certified and signed by Microsoft. They ensure optimum stability on your Windows operating system. The drivers are included in in the scope of delivery.

*) Microsoft is a registered trademark of the Microsoft Corporation.

Product range

		Part no.	Device
1.1		5970313	Label printer Hermes C 6L/300-3
		Part no.	Device options
		5970313.251	Label printer Hermes C 6L/300-3 with cover V
		5970313.261	Label printer Hermes C 6L/300-3 with cover H
		Part no.	Applicators L
2.1		5972120	Stroke applicator 4126L-300
		5972125	Stroke applicator 4126L-400
		5972290	Stroke applicator 4136L-300
		5972295	Stroke applicator 4136L-400
		xxxxxxx*)	Tamp pad 4126L-11 F WxH
		xxxxxxx*)	Tamp pad 4126L-12 F WxH
	xxxxxxx*)	Tamp pad 4126L-19 F WxH	
		xxxxxxx*)	Spring-mounted tamp pad 4126L-3900 WxH
		xxxxxxx*)	Spring-mounted tamp pad 4136L-3900 WxH
		xxxxxxx*)	Roll-on pad 4126L-4900 WxH
		xxxxxxx*)	Roll-on pad 4136L-4900 WxH
2.2		5972360	Vacuum belt applicator 5326L
		5972140	Vacuum belt applicator 5426L
		Part no.	Hermes C extra equipment
3.1		5970475.001	Cover V for vertical mounting
		5972493.001	Cover H for horizontal mounting including dust protection
3.2		5954380	External operation panel
3.3		5901626	Standard keyboard USB de
3.4		5561043	CompactFlash Type I memory card
3.5		5964300	Product sensor 25-pin Connection Hermes C
3.6		5917651	I/O interface connector Sub-D plug 25-pin Phoenix Contact No. 2761622
3.7		5961237.001	Warning light
3.8		5972287	Present sensor PS11
3.9		5955710	Hand switch TR2
		Part no.	Interfaces
4.1		5954191	Label selection - I/O box

*) User specific part no. following request

		Part no.	Connecting cable
5.1		5550818	Connecting cable RS232C 9/9-pin, length 3 m
		Part no.	Applicators extra equipment
6.1		5964095.001	Blow tube 4"
		5964614.001	Blow tube 6"
6.2		5955735	Air pressure regulation unit L
6.3		5955737	Air pressure regulation unit L with additional main valve
6.4		5918092	Circular connector 3-pin M8
		5918003	Circular connector 4-pin M8
6.5		5972xxx.212	Pressure relief valve
		Part no.	Mounting aids
7.1		5972289	Mounting foot 120
		xxxxxxx*)	Mounting foot XXX, height customized
		5972282	Adapter plate
		xxxxxxx*)	Profile XXX, length customized
7.2		5972291	Bracket C
7.3		8914443	Clamped joint for profile 50 x 50 mm
		5907394	Clamped joint for diameter 50 mm
7.4		5972230	Stand 1622
7.5		5972447	Stand 1221
		Part no.	Software
8.1		5588000	Label software cablabel S3 Lite
		5588001	cablabel S3 Pro 1 WS
		5588100	cablabel S3 Pro 5 WS
		5588101	cablabel S3 Pro 10 WS
		5588150	cablabel S3 Pro 1 addit. licence
		5588151	cablabel S3 Pro 4 addit. licence
		5588152	cablabel S3 Pro 9 addit. licence
		5588002	cablabel S3 Print 1 WS
		5588105	cablabel S3 Print 5 WS
		5588106	cablabel S3 Print 10 WS
	5588155	cablabel S3 Print 1 addit. licence	
	5588156	cablabel S3 Print 4 addit. licence	
	5588157	cablabel S3 Print 9 addit. licence	
8.2		9008486	Programming manual en, printed copy

cab delivery program

Label printer EOS1
The compact one for
label rolls up to 155 mm diameter



Label printer EOS4
The cost-effective one for
label rolls up to 210 mm diameter



Label printer EOS mobile
Both EOS sizes with
battery pack for mobile print



Label printers A+ series
The universal ones



Label printer A4+M
With centered material positioning



Label printer A4+T
With centered material positioning
also for textile materials



Label printer XD4T
Double-sided printing



Label printers XC series
Two-color printing



Label dispensers HS/VS
Precise horizontal or vertical
dispensing up to 180 mm width



Print & apply system Hermes+
For automation



Print & apply system Hermes C
For two-color printing and applying



Print modules PX series
For integration into
automatic labeling systems



Consumables
Precise printing with cab labels
and ribbons



Label software cablabel S3
Standard and optional



Laser marking system FL+ series
Precise and fast



Laser safety housing
The industrial solution



 Headquarter and fabrication in Germany

 to  International subsidiaries

There are furthermore 820 distribution partners in more than 80 countries.



Europe

Germany

cab Produkttechnik GmbH & Co KG
Wilhelm-Schickard-Str. 14
76131 Karlsruhe
phone +49 721 6626 0
fax +49 721 6626 129
info@cab.de
www.cab.de

cab Produkttechnik Sömmerda GmbH
Sömmerda GmbH
Am Unterwege 18-20
99610 Sömmerda
phone +49 3634 6860 0
fax +49 3634 6860 129
info@cab.de
www.cab.de

France

cab Technologies S.à.r.l.
2a Rue de la Moder
Z.A. Nord du Val de Moder
67350 Niedermodern
phone +33 388 722501
fax +33 388 722502
info.fr@cab.de
www.cab.de/fr

America

USA

cab Technology, Inc.
87 Progress Avenue Unit 1
Tyngsboro, MA 01879
phone +1 978 649 0293
fax +1 978 649 0294
info.us@cab.de
www.cab.de/us

Latin America

Alejandro Balmaceda
Hacienda Jurica Pte 1615
Colonial de Valle
32553 Ciudad Juárez
phone +52 656 682 3745
fax +52 656 682 4301
a.balmaceda@cab.de
www.cab.de/es

Asia

Taiwan

cab Technology Co., Ltd.
希愛比科技股份有限公司
16F-1, No. 700, Jhong Jheng Rd
Junghe, Taipei 23552
phone +886 (02) 8227 3966
fax +886 (02) 8227 3566
info.asia@cab.de
www.cab.de/tw

China

cab (Shanghai) Trading Co., Ltd.
铠博(上海)贸易有限公司
A507, No. 268, Tong Xie Rd
Shanghai 200335
phone +86 (021) 6236 3161
fax +86 (021) 6236 3162
info.cn@cab.de
www.cab.de/cn

cab (Shanghai) Trading Co., Ltd.
铠博(上海)贸易有限公司
Room 39, 10F, 8 Lin He Zhong Rd
Tian He District, Guangzhou 510610
phone +86 (020) 2831 7358
info.cn@cab.de
www.cab.de/cn

Africa

South Africa

cab Technology (Pty) Ltd.
14 Republic Street
Bordeaux
2125 Randburg
phone +27 11 886 3580
fax +27 11 789 3913
info.za@cab.de
www.cab.de/za